



Company name: ASC Water Tanks
Created by: Anant Yuvarajah
Phone: 03 8795 7715
Email: anant@asc tanks.com.au
Date: 9/10/2023

Qty. Description

1 UNILIFT AP12.40.06.1



Note! Product picture may differ from actual product

Product No.: [96001729](#)

Submersible drainage pump type

Vertical single-stage stainless steel submersible pump with vertical discharge port and integrated submersible 1-phase totally enclosed motor in insulation class F with thermal overload protection. The pump is fitted with a suction strainer.

The impeller is a SEMI OPEN impeller for groundwater, surface water, rain water and similar.

The pump has a double shaft seal and an intermediate oil chamber pre-filled with non-toxic special oil.

The pump has a riser pipe, a cooling jacket for continuous cooling of the motor by the pumped liquid and long-life deep-groove greased-for-life ball bearings.

The pump is ready for use as it is fitted with carrying handle and is supplied with a 10 m mains cable. The mains cable is of the plug type with glass sealing compound in the socket to prevent penetration of humidity into the stator windings.

Liquid:
Liquid temperature range: 0 .. 55 °C
Density: 998.2 kg/m³

Technical:
Maximum flow: 300 l/min
Type of impeller: SEMI OPEN
Max. Particle: 12 mm
Approvals: CE,RCM,LGABG,EAC,TUVRHWID
Rated speed: 2785 rpm

Materials:
Pump housing: Stainless steel
EN 1.4301
AISI 304

Impeller: Stainless steel



Company name: ASC Water Tanks
Created by: Anant Yuvarajah
Phone: 03 8795 7715
Email: anant@asc tanks.com.au
Date: 9/10/2023

Qty. Description

1	EN 1.4301 AISI 304 Cable union: Brass CW602N C35330 Installation: Range of ambient temperature: 0 .. 55 °C Type of connection: Rp Size of connection: 1 1/2 inch Maximum installation depth: 7 m Place of installation: Indoor/outdoor Electrical data: Power input P1: 0.9 kW Motor type 1-phase: PSC Rated power - P2: 0.6 kW Mains frequency: 50 Hz Rated voltage: 1 x 220-240 V Rated current: 4.4 A Cos phi - power factor: 0.99 Rated speed: 2785 rpm Capacitor size - run: 16 µF/400 V Enclosure class (IEC 34-5): IP68 Insulation class (IEC 85): F Length of power cable: 10 m Type of cable plug: AU Others: Net weight: 12 kg Gross weight: 12.5 kg Country of origin: DK Custom tariff no.: 8413709019182742 Environmental approvals: WEEE
---	--



Company name: ASC Water Tanks
Created by: Anant Yuvarajah
Phone: 03 8795 7715
Email: anant@asc tanks.com.au
Date: 9/10/2023

96001729 UNILIFT AP12.40.06.1 50 Hz

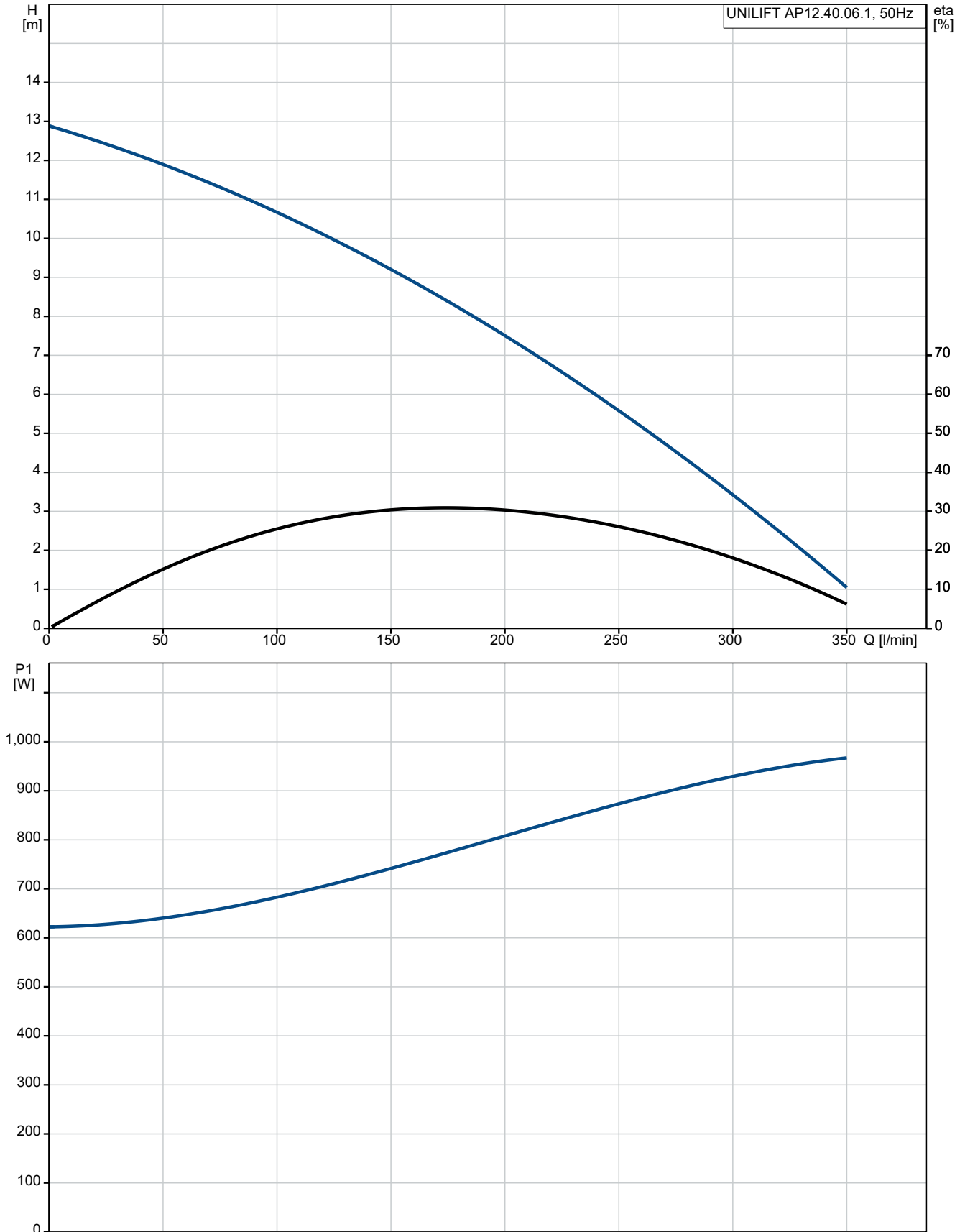



Company name: ASC Water Tanks
Created by: Anant Yuvarajah
Phone: 03 8795 7715
Email: anant@asc tanks.com.au
Date: 9/10/2023

Description	Value
General information:	
Product name:	UNILIFT AP12.40.06.1
Product No:	96001729
EAN number:	5700390471941
Price:	AUD 1015
Technical:	
Maximum flow:	300 l/min
Maximum head:	13 m
Type of impeller:	SEMI OPEN
Max. Particle:	12 mm
Approvals:	CE,RCM,LGABG,EAC,TUVRHWD
Rated speed:	2785 rpm
Materials:	
Pump housing:	Stainless steel
Pump housing:	EN 1.4301
Pump housing:	AISI 304
Impeller:	Stainless steel
Impeller:	EN 1.4301
Impeller:	AISI 304
Cable union:	Brass
Cable union:	CW602N
Cable union:	C35330
Installation:	
Range of ambient temperature:	0 .. 55 °C
Type of connection:	Rp
Size of connection:	1 1/2 inch
Maximum installation depth:	7 m
Inst dry/wet:	D/S
Installation:	horizontal or vertical
Place of installation:	Indoor/outdoor
Liquid:	
Liquid temperature range:	0 .. 55 °C
Density:	998.2 kg/m ³
Electrical data:	
Power input P1:	0.9 kW
Motor type 1-phase:	PSC
Rated power - P2:	0.6 kW
Mains frequency:	50 Hz
Rated voltage:	1 x 220-240 V
Rated current:	4.4 A
Cos phi - power factor:	0.99
Rated speed:	2785 rpm
Capacitor size - run:	16 µF/400 V
Enclosure class (IEC 34-5):	IP68
Insulation class (IEC 85):	F
Built-in motor protection:	CONTACT
Thermal protec:	internal
Length of power cable:	10 m
Type of cable plug:	AU
Others:	
Net weight:	12 kg
Gross weight:	12.5 kg
Country of origin:	DK
Custom tariff no.:	8413709019182742
Environmental approvals:	WEEE

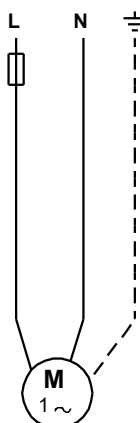
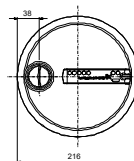
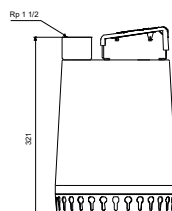
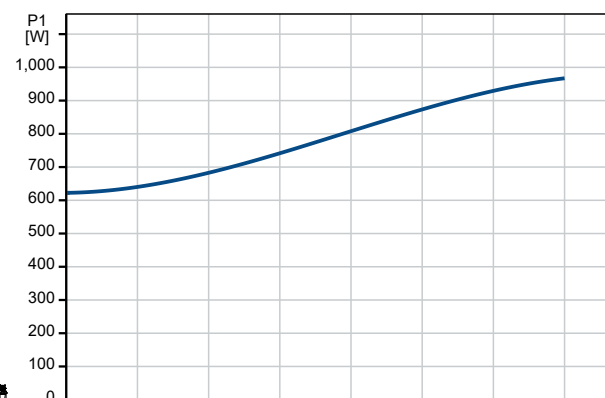
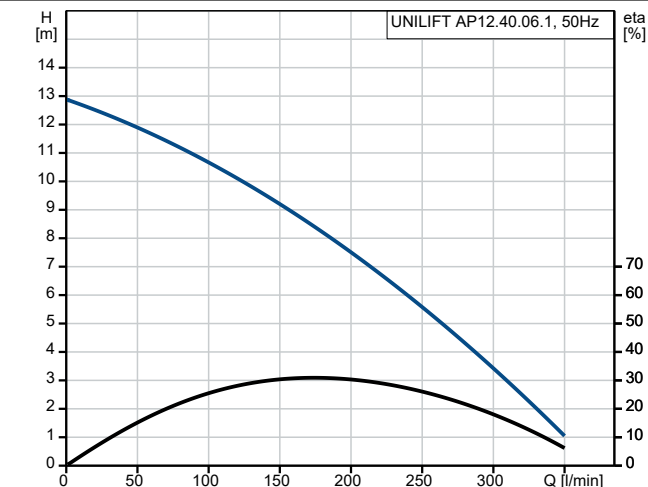



Company name: ASC Water Tanks
Created by: Anant Yuvarajah
Phone: 03 8795 7715
Email: anant@asctanks.com.au
Date: 9/10/2023

96001729 UNILIFT AP12.40.06.1 50 Hz

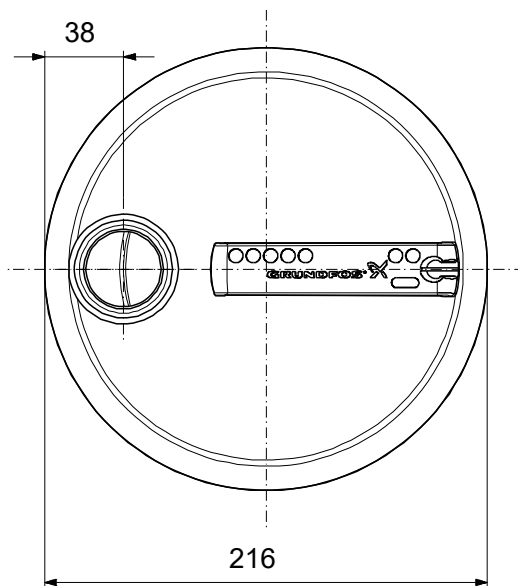
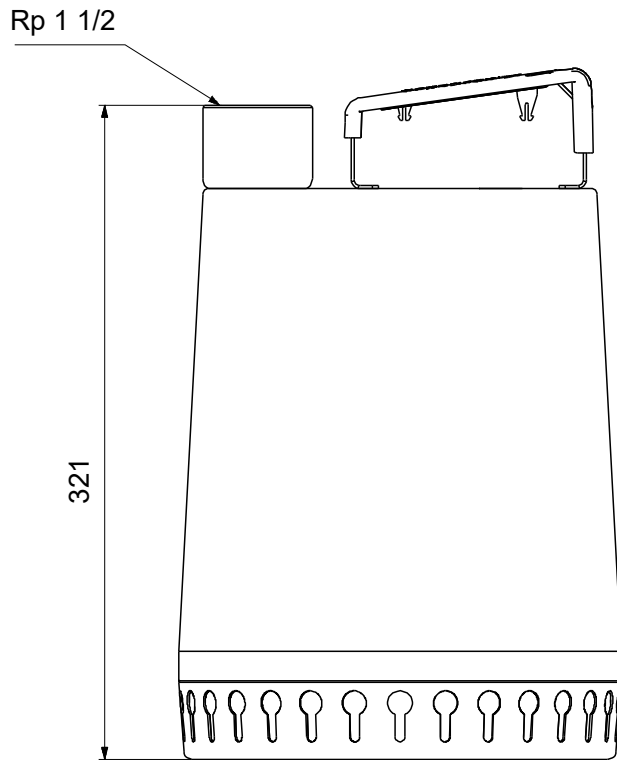

Note! All units are in [mm] unless others are stated.
Disclaimer: This simplified dimensional drawing does not show all details.



Company name: ASC Water Tanks
Created by: Anant Yuvarajah
Phone: 03 8795 7715
Email: anant@asc tanks.com.au
Date: 9/10/2023

Spare parts UNILIFT AP12.40.06.1, Product No. 96001729
Produced After 9851 (production year and week number)

Pos	Description	Annotation	Classification Data	Part no.	Qty.	Unit
-	Kit, Shaft seal		Type: NBR	96427804	1	pcs
-	Kit, Oil pipe			98839054	1	pcs
	Oil				1	pcs
	Oil		Material type: ONDINA P68/G34		1	pcs
			Type: SHELL			
-	Screw w/O-ring				2	pcs
193	Pan washer head				1	pcs
194	O-ring		Diameter: 4,9		1	pcs
			Material type: NBR70			
			Thickness: 1,9			
37a	O-ring				1	pcs
37a	O-ring		Diameter: 208		1	pcs
			Material type: NBR			
			Thickness: 4,0			
66	Spring lock washer		Designation: DIN 127 B		1	pcs
66	Disc spring				1	pcs
67	Lock nut		Thread: M8		1	pcs
67	Nut				1	pcs
105a	Shaft seal		Material type: BQQP		1	pcs
188a	Hex socket head cap screw		Designation: DIN 912		6	pcs
			Length (mm): 12			
			Thread: M6			
198	O-ring		Diameter: 27		2	pcs
			Material type: NBR			
			Thickness: 2,5			
-	Kit, Shaft seal BQQV			96426650	1	pcs
-	Kit, Oil pipe			98839054	1	pcs
	Oil				1	pcs
	Oil		Material type: ONDINA P68/G34		1	pcs
			Type: SHELL			
37a	O-ring		Diameter: 230		1	pcs
			Material type: FKM			
			Thickness: 4			
37a	O-ring		Diameter: 208		1	pcs
			Material type: FKM			
			Thickness: 4,5			
66c	Adapter		Dimension: M10/M8		1	pcs
66	Spring lock washer		Designation: DIN 127 B		1	pcs
66	Disc spring				1	pcs
67a	Protective cap				1	pcs
67	Lock nut		Thread: M8		1	pcs
67	Nut				1	pcs
105a	Shaft seal		Material type: BQQV		1	pcs
188a	Hex socket head cap screw		Designation: DIN 912		6	pcs
			Length (mm): 12			
			Thread: M6			
194	Screw w/O-ring				2	pcs
198	O-ring		Diameter: 27		2	pcs
			Material type: NBR			
			Thickness: 2,5			
-	Pump				1	pcs
6	Pump housing			96548084	1	pcs
31	Pipe			99413604	1	pcs



Company name: ASC Water Tanks
Created by: Anant Yuvarajah
Phone: 03 8795 7715
Email: anant@asc tanks.com.au
Date: 9/10/2023

Pos	Description	Annotation	Classification Data	Part no.	Qty.	Unit
37a	O-ring			96549891	1	pcs
+ 49	Bulk, Impeller (10 PC)			96537512	1	pcs
55	Pump housing			96586345	1	pcs
67	Bulk, Nut (20 PC)			97511769	1	pcs
84	Strainer			96548086	1	pcs
105a	Bulk, Shaft seal (10 PC)		Material type: BQQP	96536518	1	pcs
+ 150	Motor unit		Winding resistance, main: 3,80-4,80	96586366	1	pcs
189	Handle			96551528	1	pcs
190	Handle			96549895	1	pcs
198	O-ring		Diameter: 27 Material type: NBR Thickness: 2,5	96549894	1	pcs
+ 181	Cable			98784186	1	pcs