



**Company name:** ASC Water Tanks  
**Created by:** Anant Yuvarajah  
**Phone:** 03 8795 7715  
**Email:** anant@asc tanks.com.au  
**Date:** 9/10/2023

**Qty. Description**

1 UNILIFT AP12.40.08.3



Note! Product picture may differ from actual product

Product No.: 96001791

Submersible drainage pump type

Vertical single-stage stainless steel submersible pump with vertical discharge port and integrated submersible 3-phase totally enclosed motor in insulation class F. The pump is fitted with a suction strainer.

The impeller is a SEMI OPEN impeller for groundwater, surface water, rain water and similar.

The pump has a double shaft seal and an intermediate oil chamber pre-filled with non-toxic special oil.

The pump has a riser pipe, a cooling jacket for continuous cooling of the motor by the pumped liquid and long-life deep-groove greased-for-life ball bearings.

The pump is ready for use as it is fitted with carrying handle and is supplied with a 10 m mains cable. The mains cable is of the plug type with glass sealing compound in the socket to prevent penetration of humidity into the stator windings.

Liquid:

Liquid temperature range: 0 .. 55 °C

Density: 998.2 kg/m<sup>3</sup>

Technical:

Maximum flow: 350 l/min

Type of impeller: SEMI OPEN

Max. Particle: 12 mm

Approvals: CE,RCM,VDE,LGABG,EAC,TUVRHWID,MORO,UKCA,CNROHSEXP,SEPRO

Rated speed: 2810 rpm

Materials:

Pump housing: Stainless steel

EN 1.4301

AISI 304

Impeller: Stainless steel

EN 1.4301



**Company name:** ASC Water Tanks  
**Created by:** Anant Yuvarajah  
**Phone:** 03 8795 7715  
**Email:** anant@asctanks.com.au  
**Date:** 9/10/2023

**Qty. Description**

|                               |                |
|-------------------------------|----------------|
| 1                             | AISI 304       |
| Cable union:                  | Brass          |
|                               | CW602N         |
|                               | C35330         |
| Installation:                 |                |
| Range of ambient temperature: | 0 .. 55 °C     |
| Type of connection:           | Rp             |
| Size of connection:           | 1 1/2 inch     |
| Maximum installation depth:   | 7 m            |
| Place of installation:        | Indoor/outdoor |
| Electrical data:              |                |
| Power input P1:               | 1.2 kW         |
| Rated power - P2:             | 0.8 kW         |
| Mains frequency:              | 50 Hz          |
| Rated voltage:                | 3 x 400 V      |
| Rated current:                | 2.1 A          |
| Cos phi - power factor:       | 0.87           |
| Rated speed:                  | 2810 rpm       |
| Enclosure class (IEC 34-5):   | IP68           |
| Insulation class (IEC 85):    | F              |
| Length of power cable:        | 10 m           |
| Type of cable plug:           | NONE           |
| Others:                       |                |
| Net weight:                   | 14.4 kg        |
| Gross weight:                 | 15.8 kg        |
| Danish VVS No.:               | 391314131      |
| Swedish RSK No.:              | 5880115        |
| Finnish LVI No.:              | 4822579        |
| Country of origin:            | HU             |
| Custom tariff no.:            | 8413709062     |
| Environmental approvals:      | WEEE           |



Company name: ASC Water Tanks  
Created by: Anant Yuvarajah  
Phone: 03 8795 7715  
Email: anant@asc tanks.com.au  
Date: 9/10/2023

### 96001791 UNILIFT AP12.40.08.3 50 Hz

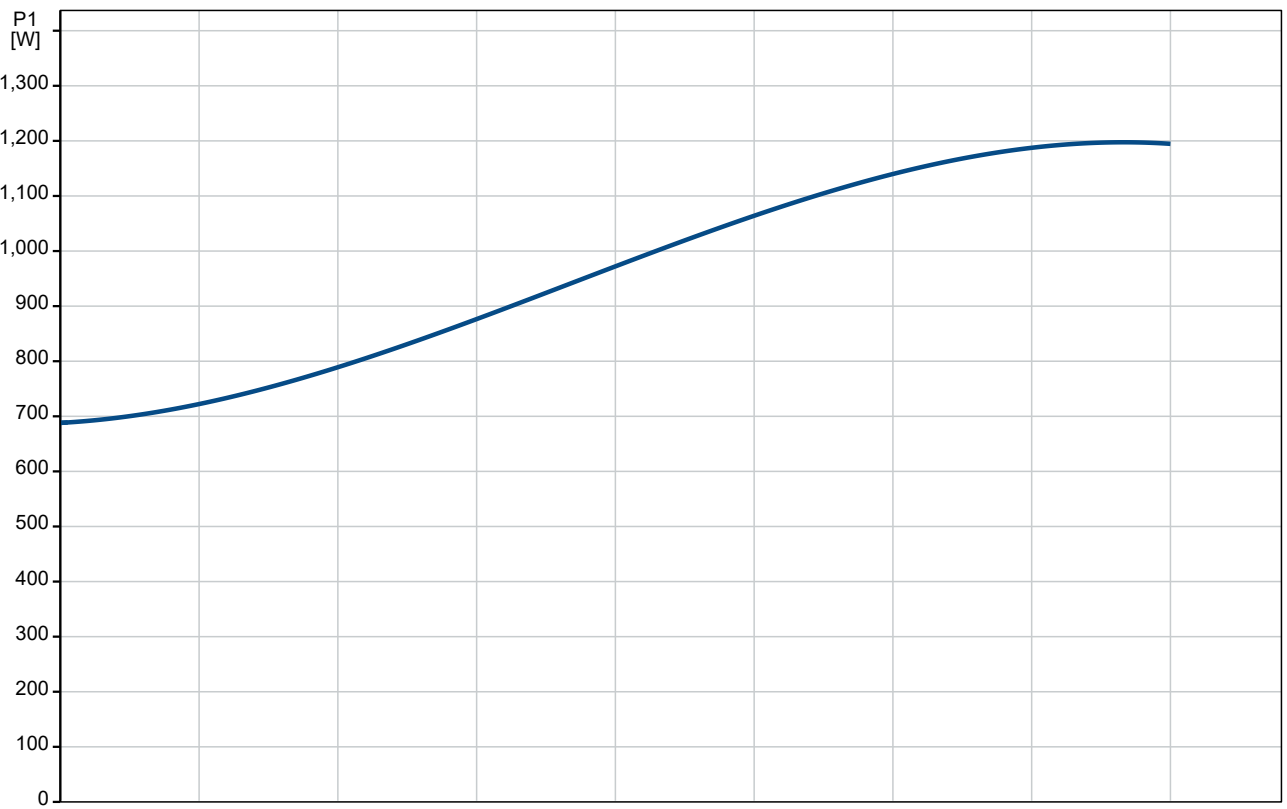
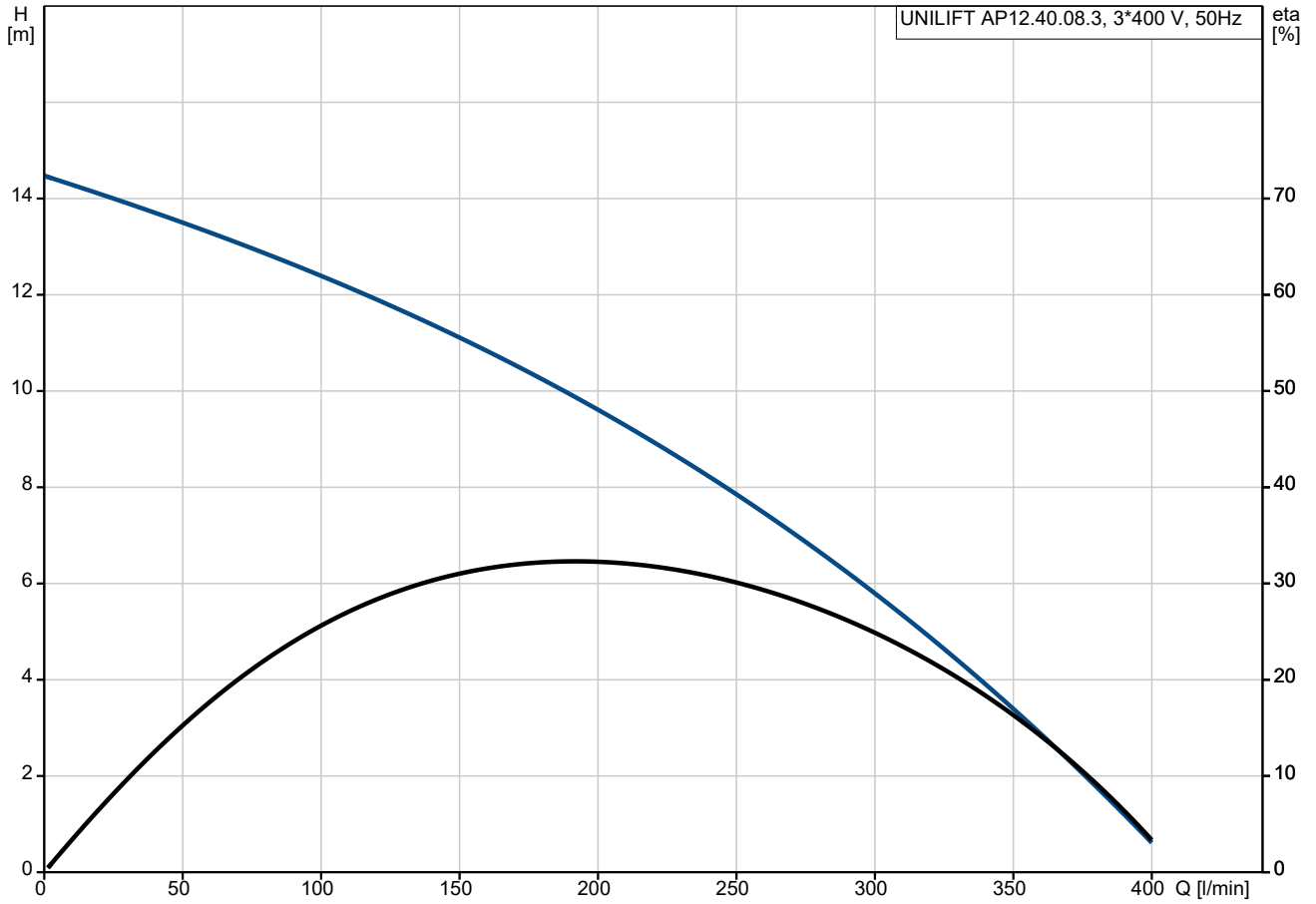



**Company name:** ASC Water Tanks  
**Created by:** Anant Yuvarajah  
**Phone:** 03 8795 7715  
**Email:** anant@asc tanks.com.au  
**Date:** 9/10/2023

| Description                   | Value   |
|-------------------------------|---|
| <b>General information:</b>   |   |
| Product name:                 | UNILIFT AP12.40.08.3                                      |
| Product No:                   | 96001791  |
| EAN number:                   | 5700390897161   |
| Price:                        | AUD 1077  |
| <b>Technical:</b>             |   |
| Maximum flow:                 | 350 l/min   |
| Maximum head:                 | 15 m  |
| Type of impeller:             | SEMI OPEN   |
| Max. Particle:                | 12 mm   |
| Approvals:                    | CE,RCM,VDE,LGABG,EAC,TUV RHWID,MORO,UKCA,CNROHSE XP,SEPRO |
| Rated speed:                  | 2810 rpm  |
| <b>Materials:</b>             |   |
| Pump housing:                 | Stainless steel   |
| Pump housing:                 | EN 1.4301   |
| Pump housing:                 | AISI 304  |
| Impeller:                     | Stainless steel   |
| Impeller:                     | EN 1.4301   |
| Impeller:                     | AISI 304  |
| Cable union:                  | Brass   |
| Cable union:                  | CW602N  |
| Cable union:                  | C35330  |
| <b>Installation:</b>          |   |
| Range of ambient temperature: | 0 .. 55 °C  |
| Type of connection:           | Rp  |
| Size of connection:           | 1 1/2 inch  |
| Maximum installation depth:   | 7 m   |
| Inst dry/wet:                 | D/S   |
| Installation:                 | horizontal or vertical                                    |
| Place of installation:        | Indoor/outdoor  |
| <b>Liquid:</b>                |   |
| Liquid temperature range:     | 0 .. 55 °C  |
| Density:                      | 998.2 kg/m <sup>3</sup>                                   |
| <b>Electrical data:</b>       |   |
| Power input P1:               | 1.2 kW  |
| Rated power - P2:             | 0.8 kW  |
| Mains frequency:              | 50 Hz   |
| Rated voltage:                | 3 x 400 V   |
| Rated current:                | 2.1 A   |
| Cos phi - power factor:       | 0.87  |
| Rated speed:                  | 2810 rpm  |
| Enclosure class (IEC 34-5):   | IP68  |
| Insulation class (IEC 85):    | F   |
| Built-in motor protection:    | NONE  |
| Thermal protec:               | external  |
| Length of power cable:        | 10 m  |
| Type of cable plug:           | NONE  |
| <b>Others:</b>                |   |
| Net weight:                   | 14.4 kg   |
| Gross weight:                 | 15.8 kg   |
| Danish VVS No.:               | 391314131   |
| Swedish RSK No.:              | 5880115   |
| Finnish LVI No.:              | 4822579   |
| Country of origin:            | HU  |
| Custom tariff no.:            | 8413709062  |
| Environmental approvals:      | WEEE  |

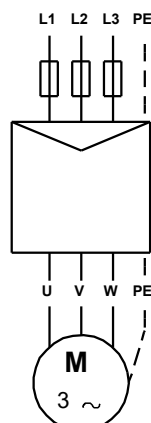
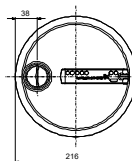
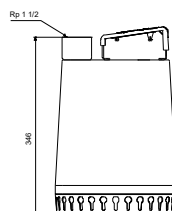
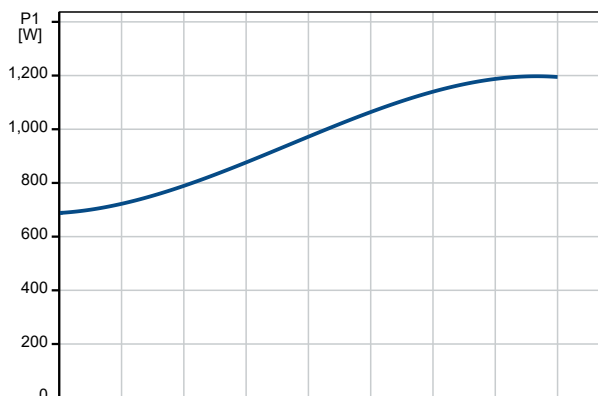
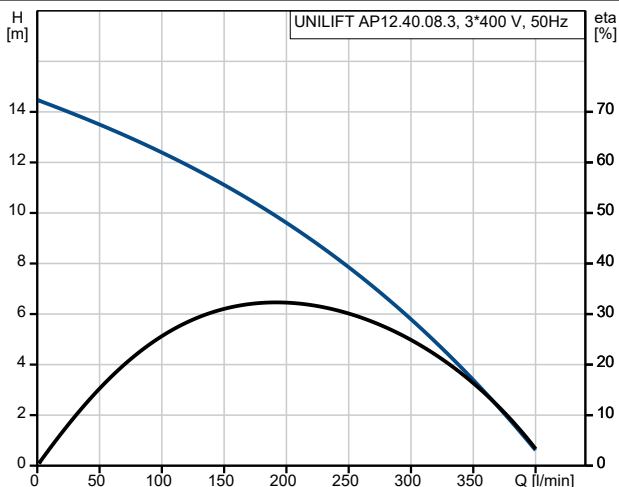



Company name: ASC Water Tanks  
Created by: Anant Yuvarajah  
Phone: 03 8795 7715  
Email: anant@asc tanks.com.au  
Date: 9/10/2023

### 96001791 UNILIFT AP12.40.08.3 50 Hz

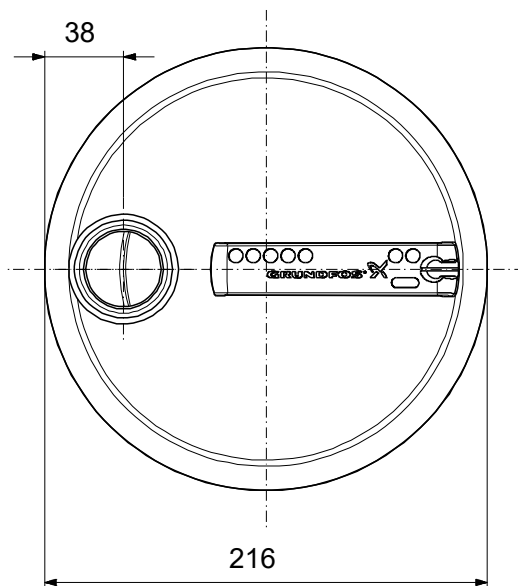
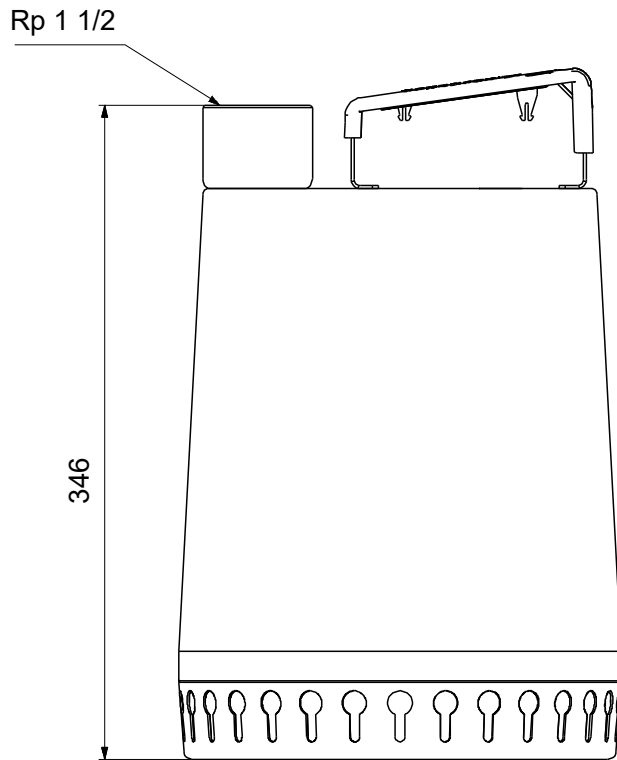

Note! All units are in [mm] unless others are stated.  
Disclaimer: This simplified dimensional drawing does not show all details.



**Company name:** ASC Water Tanks  
**Created by:** Anant Yuvarajah  
**Phone:** 03 8795 7715  
**Email:** anant@asc tanks.com.au  
**Date:** 9/10/2023

**Spare parts UNILIFT AP12.40.08.3, Product No. 96001791**  
**Produced After 9851 (production year and week number)**

| Pos  | Description               | Annotation | Classification Data           | Part no. | Qty. | Unit |
|------|---------------------------|------------|-------------------------------|----------|------|------|
| -    | Kit, Shaft seal           |            | Type: NBR                     | 96427804 | 1    | pcs  |
| -    | Kit, Oil pipe             |            |                               | 98839054 | 1    | pcs  |
|      | Oil                       |            |                               |          | 1    | pcs  |
|      | Oil                       |            | Material type: ONDINA P68/G34 |          | 1    | pcs  |
|      |                           |            | Type: SHELL                   |          |      |      |
| -    | Screw w/O-ring            |            |                               |          | 2    | pcs  |
| 193  | Pan washer head           |            |                               |          | 1    | pcs  |
| 194  | O-ring                    |            | Diameter: 4,9                 |          | 1    | pcs  |
|      |                           |            | Material type: NBR70          |          |      |      |
|      |                           |            | Thickness: 1,9                |          |      |      |
| 37a  | O-ring                    |            |                               |          | 1    | pcs  |
| 37a  | O-ring                    |            | Diameter: 208                 |          | 1    | pcs  |
|      |                           |            | Material type: NBR            |          |      |      |
|      |                           |            | Thickness: 4,0                |          |      |      |
| 66   | Spring lock washer        |            | Designation: DIN 127 B        |          | 1    | pcs  |
| 66   | Disc spring               |            |                               |          | 1    | pcs  |
| 67   | Lock nut                  |            | Thread: M8                    |          | 1    | pcs  |
| 67   | Nut                       |            |                               |          | 1    | pcs  |
| 105a | Shaft seal                |            | Material type: BQQP           |          | 1    | pcs  |
| 188a | Hex socket head cap screw |            | Designation: DIN 912          |          | 6    | pcs  |
|      |                           |            | Length (mm): 12               |          |      |      |
|      |                           |            | Thread: M6                    |          |      |      |
| 198  | O-ring                    |            | Diameter: 27                  |          | 2    | pcs  |
|      |                           |            | Material type: NBR            |          |      |      |
|      |                           |            | Thickness: 2,5                |          |      |      |
| -    | Kit, Shaft seal BQQV      |            |                               | 96426650 | 1    | pcs  |
| -    | Kit, Oil pipe             |            |                               | 98839054 | 1    | pcs  |
|      | Oil                       |            |                               |          | 1    | pcs  |
|      | Oil                       |            | Material type: ONDINA P68/G34 |          | 1    | pcs  |
|      |                           |            | Type: SHELL                   |          |      |      |
| 37a  | O-ring                    |            | Diameter: 230                 |          | 1    | pcs  |
|      |                           |            | Material type: FKM            |          |      |      |
|      |                           |            | Thickness: 4                  |          |      |      |
| 37a  | O-ring                    |            | Diameter: 208                 |          | 1    | pcs  |
|      |                           |            | Material type: FKM            |          |      |      |
|      |                           |            | Thickness: 4,5                |          |      |      |
| 66c  | Adapter                   |            | Dimension: M10/M8             |          | 1    | pcs  |
| 66   | Spring lock washer        |            | Designation: DIN 127 B        |          | 1    | pcs  |
| 66   | Disc spring               |            |                               |          | 1    | pcs  |
| 67a  | Protective cap            |            |                               |          | 1    | pcs  |
| 67   | Lock nut                  |            | Thread: M8                    |          | 1    | pcs  |
| 67   | Nut                       |            |                               |          | 1    | pcs  |
| 105a | Shaft seal                |            | Material type: BQQV           |          | 1    | pcs  |
| 188a | Hex socket head cap screw |            | Designation: DIN 912          |          | 6    | pcs  |
|      |                           |            | Length (mm): 12               |          |      |      |
|      |                           |            | Thread: M6                    |          |      |      |
| 194  | Screw w/O-ring            |            |                               |          | 2    | pcs  |
| 198  | O-ring                    |            | Diameter: 27                  |          | 2    | pcs  |
|      |                           |            | Material type: NBR            |          |      |      |
|      |                           |            | Thickness: 2,5                |          |      |      |
| -    | Pump                      |            |                               |          | 1    | pcs  |
| 6    | Pump housing              |            |                               | 96548084 | 1    | pcs  |
| 31   | Riser pipe                |            |                               | 99343230 | 1    | pcs  |



**Company name:** ASC Water Tanks  
**Created by:** Anant Yuvarajah  
**Phone:** 03 8795 7715  
**Email:** anant@asctanks.com.au  
**Date:** 9/10/2023

| Pos   | Description                 | Annotation | Classification Data                                  | Part no. | Qty. | Unit |
|-------|-----------------------------|------------|--|----------|------|------|
| 37a   | O-ring                      |            |  | 96549891 | 1    | pcs  |
| + 49  | Bulk, Impeller cpl. (10 PC) |            |  | 96537515 | 1    | pcs  |
| 55    | Pump sleeve                 |            |  | 96551533 | 1    | pcs  |
| 67    | Bulk, Nut (20 PC)           |            |  | 97511769 | 1    | pcs  |
| 84    | Strainer                    |            |  | 96548086 | 1    | pcs  |
| 105a  | Bulk, Shaft seal (10 PC)    |            | Material type: BQQP                                  | 96536518 | 1    | pcs  |
| 189   | Handle                      |            |  | 96551528 | 1    | pcs  |
| 190   | Handle                      |            |  | 96549895 | 1    | pcs  |
| 198   | O-ring                      |            | Diameter: 27<br>Material type: NBR<br>Thickness: 2,5 | 96549894 | 1    | pcs  |
| + 181 | Cable                       |            |  | 96548100 | 1    | pcs  |