

**Qty. Description**

1 UNILIFT AP12.40.04.A1



**Note! Product picture may differ from actual product**

Product No.: [96023914](#)

Submersible drainage pump type

Vertical single-stage stainless steel submersible pump with vertical discharge port and integrated submersible 1-phase totally enclosed motor in insulation class F with thermal overload protection.

The pump is fitted with suction strainer and level switch for automatic start and stop.

The impeller is a SEMI OPEN impeller for groundwater, surface water, rain water and similar.

The pump has a double shaft seal and an intermediate oil chamber pre-filled with non-toxic special oil.

The pump has a riser pipe, a cooling jacket for continuous cooling of the motor by the pumped liquid and long-life deep-groove greased-for-life ball bearings.

The pump is ready for use as it is fitted with carrying handle and is supplied with a 10 m mains cable. The mains cable is of the plug type with glass sealing compound in the socket to prevent penetration of humidity into the stator windings.

**Liquid:**  
 Liquid temperature range: 0 .. 55 °C  
 Density: 998.2 kg/m<sup>3</sup>

**Technical:**  
 Maximum flow: 3.89 l/s  
 Type of impeller: SEMI OPEN  
 Max. Particle: 12 mm  
 Approvals: CE,RCM,LGABG,EAC,TUVRHWID  
 Rated speed: 2770 rpm

**Materials:**  
 Pump housing: Stainless steel  
 EN 1.4301

Qty.	Description
1	<p> <b>Impeller:</b> AISI 304            Stainless steel            EN 1.4301         </p> <p> <b>Cable union:</b> AISI 304            Brass            CW602N            C35330         </p> <p> <b>Installation:</b>            Range of ambient temperature: 0 .. 55 °C            Type of connection: Rp            Size of connection: 1 1/2 inch            Maximum installation depth: 7 m            Place of installation: Indoor/outdoor         </p> <p> <b>Electrical data:</b>            Power input P1: 0.7 kW            Motor type 1-phase: PSC            Rated power - P2: 0.4 kW            Mains frequency: 50 Hz            Rated voltage: 1 x 220-240 V            Rated current: 3 A            Cos phi - power factor: 0.99            Rated speed: 2770 rpm            Capacitor size - run: 12 µF/400 V            Enclosure class (IEC 34-5): IP68            Insulation class (IEC 85): F            Length of power cable: 10 m            Type of cable plug: AU         </p> <p> <b>Others:</b>            Net weight: 10.7 kg            Gross weight: 11.7 kg            Country of origin: DK            Custom tariff no.: 8413709019182742            Environmental approvals: WEEE         </p>



Company name: ASC Water Tanks  
Created by: Anant Yuvarajah  
Phone: 03 8795 7715  
Email: anant@asctanks.com.au  
Date: 8/30/2023

### 96023914 UNILIFT AP12.40.04.A1 50 Hz

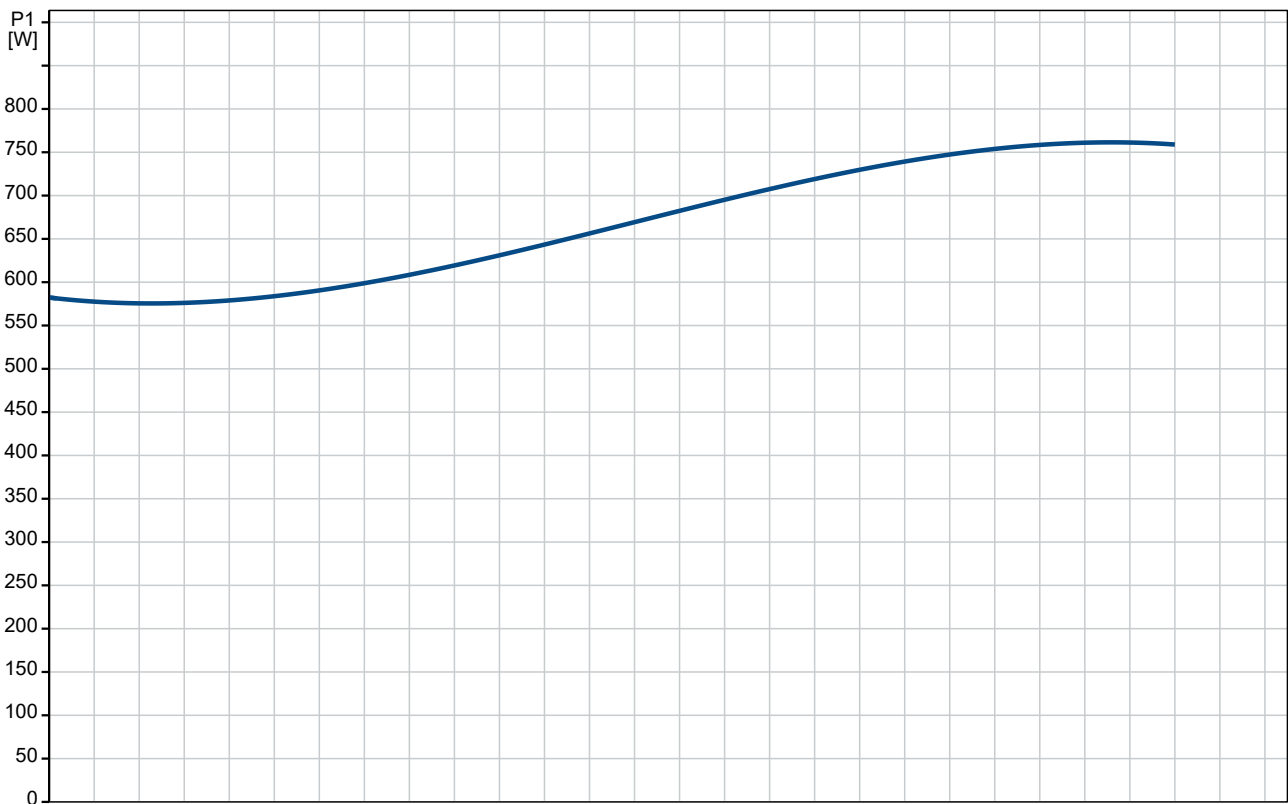
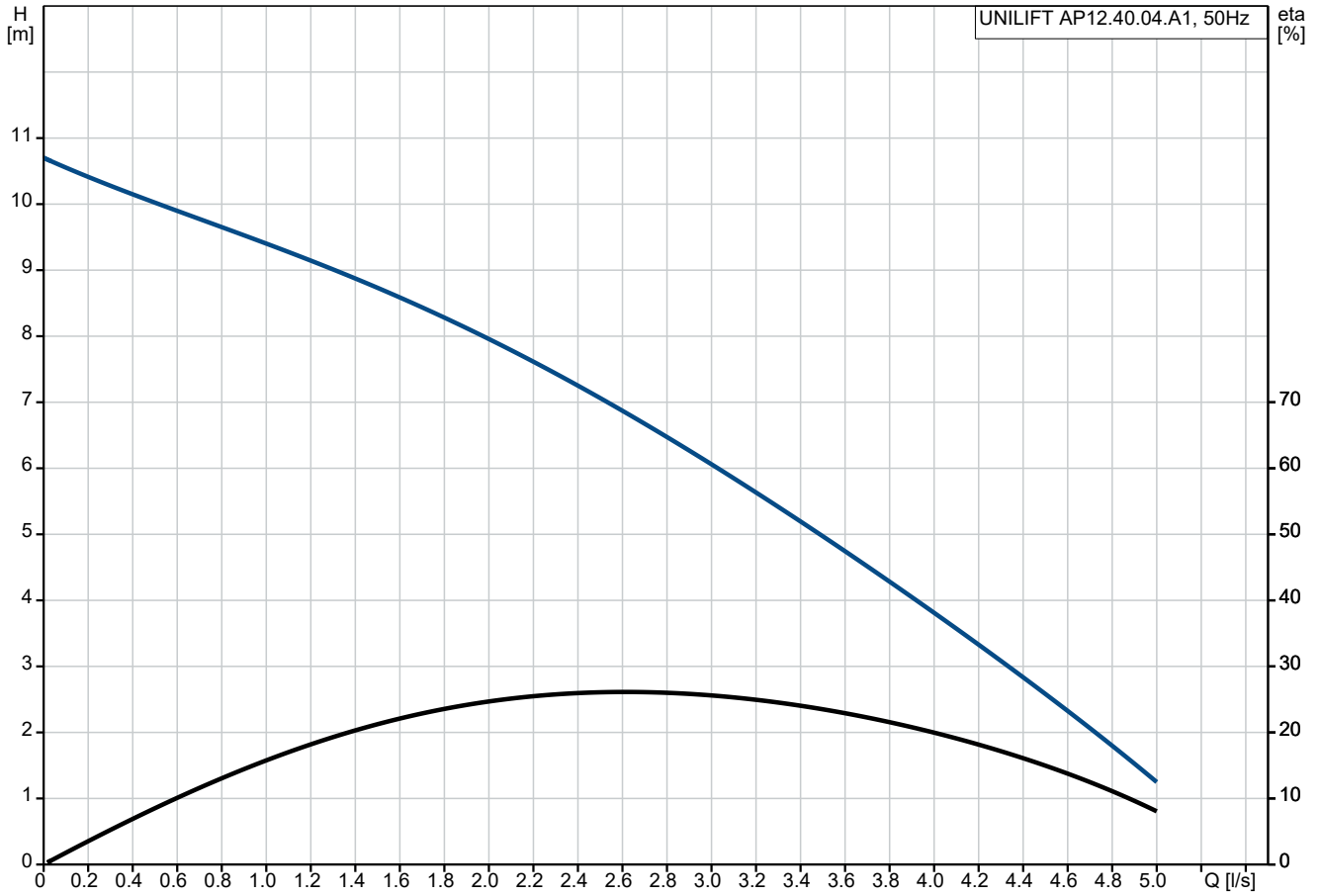

Description	Value
<b>General information:</b>	
Product name:	UNILIFT AP12.40.04.A1
Product No:	96023914
EAN number:	5700390548599
Price:	AUD 1053
<b>Technical:</b>	
Maximum flow:	3.89 l/s
Maximum head:	10 m
Type of impeller:	SEMI OPEN
Max. Particle:	12 mm
Approvals:	CE,RCM,LGABG,EAC,TUVRHWD
Rated speed:	2770 rpm
<b>Materials:</b>	
Pump housing:	Stainless steel
Pump housing:	EN 1.4301
Pump housing:	AISI 304
Impeller:	Stainless steel
Impeller:	EN 1.4301
Impeller:	AISI 304
Cable union:	Brass
Cable union:	CW602N
Cable union:	C35330
<b>Installation:</b>	
Range of ambient temperature:	0 .. 55 °C
Type of connection:	Rp
Size of connection:	1 1/2 inch
Maximum installation depth:	7 m
Inst dry/wet:	D/S
Installation:	horizontal or vertical
Place of installation:	Indoor/outdoor
<b>Liquid:</b>	
Liquid temperature range:	0 .. 55 °C
Density:	998.2 kg/m <sup>3</sup>
<b>Electrical data:</b>	
Power input P1:	0.7 kW
Motor type 1-phase:	PSC
Rated power - P2:	0.4 kW
Mains frequency:	50 Hz
Rated voltage:	1 x 220-240 V
Rated current:	3 A
Cos phi - power factor:	0.99
Rated speed:	2770 rpm
Capacitor size - run:	12 µF/400 V
Enclosure class (IEC 34-5):	IP68
Insulation class (IEC 85):	F
Built-in motor protection:	CONTACT
Thermal protec:	internal
Length of power cable:	10 m
Type of cable plug:	AU
<b>Controls:</b>	
Level switch:	float switch
<b>Others:</b>	
Net weight:	10.7 kg
Gross weight:	11.7 kg
Country of origin:	DK
Custom tariff no.:	8413709019182742
Environmental approvals:	WEEE

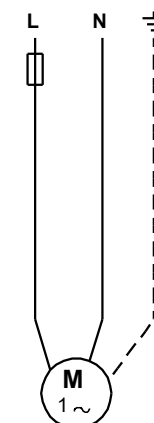
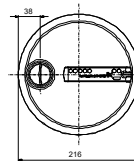
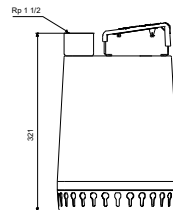
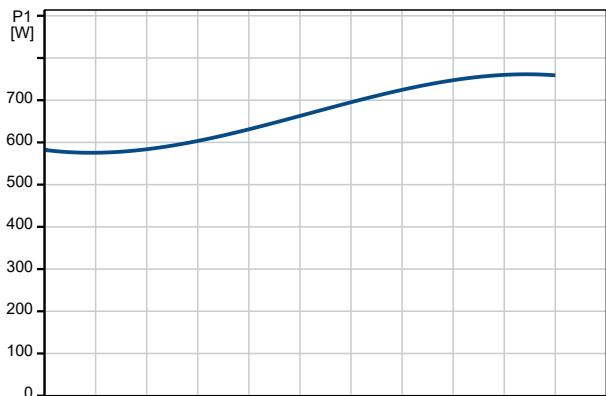
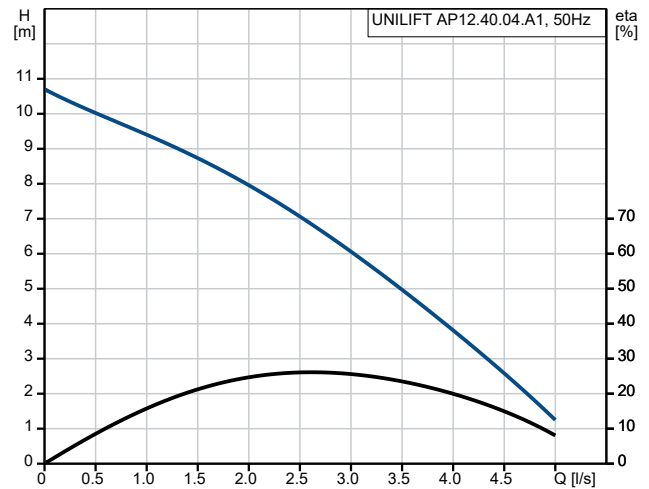

**96023914 UNILIFT AP12.40.04.A1 50 Hz**

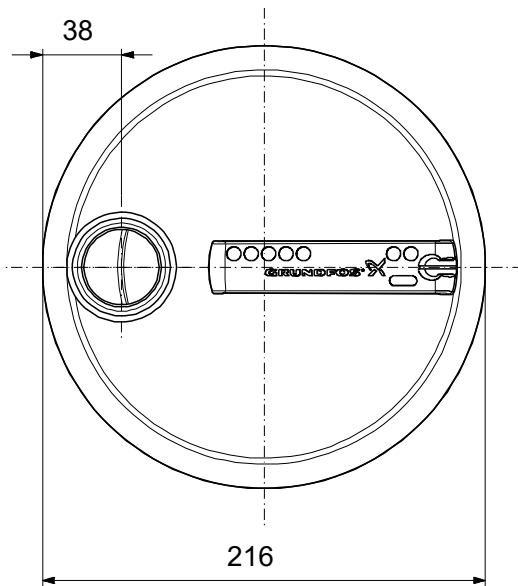
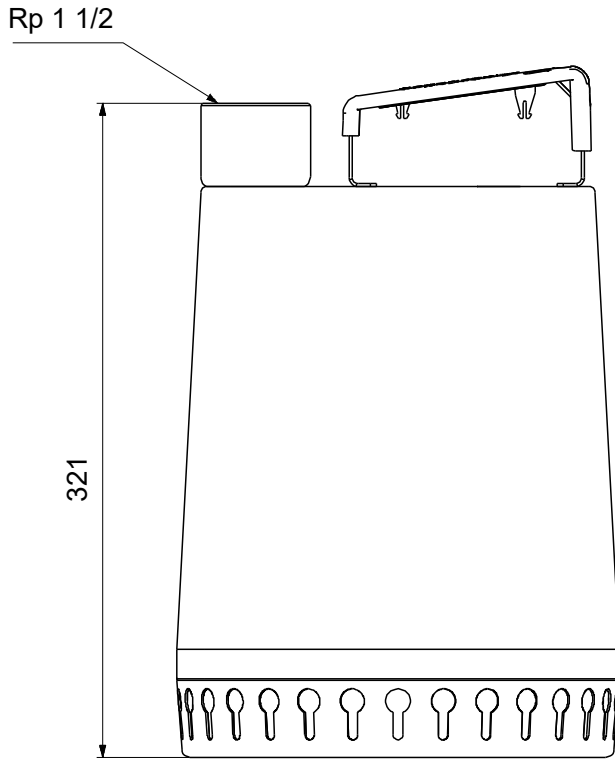

Note! All units are in [mm] unless others are stated.  
Disclaimer: This simplified dimensional drawing does not show all details.