



Company name: ASC Water Tanks
Created by: Anant Yuvarajah
Phone: 0414880162
Email: anant@asc tanks.com.au
Date: 15/06/2022

Qty. Description

1 UNILIFT KP.150.M.1



Note! Product picture may differ from actual product

Product No.: [011K4100](#)

Submersible drainage pump

Vertical single-stage stainless steel submersible pump with vertical discharge port and integrated submersible 1-phase canned motor in insulation class F with thermal overload protection.

The pump is fitted with a suction strainer, a carrying handle and is supplied with a 5 m mains cable.

The impeller is a semi-open impeller for 10 mm free passage suitable for pumping groundwater, surface water, rain water and similar liquids.

The pump has a double shaft seal consisting of two lip seals with grease in-between.

The pump has an outer casing ensuring continuous cooling of the motor by the pumped liquid. The rotor shaft operates in two maintenance-free carbon bearings cooled by the pumped liquid

The motor is filled with a non-toxic motor liquid.

Liquid:

Liquid temperature range: 0 .. 50 °C

Density: 998.2 kg/m³

Technical:

Maximum flow: 142 l/min

Max. Particle: 10 mm

Approvals: CE,RCM,LGABG,EAC,TUVRHWID

Materials:

Pump housing: Stainless steel
EN 1.4301
AISI 304

Impeller: Stainless steel
EN 1.4301
AISI 304

Installation:

Range of ambient temperature: 0 .. 50 °C



Company name: ASC Water Tanks
Created by: Anant Yuvarajah
Phone: 0414880162
Email: anant@asc tanks.com.au
Date: 15/06/2022

Qty.	Description
------	-------------

Type of connection:	Rp
Size of connection:	1 1/4 inch
Maximum installation depth:	2 m
Electrical data:	
Power input - P1:	300 W
Mains frequency:	50 Hz
Rated voltage [V]:	1 x 230-240 V
Rated current:	1.3 A
Capacitor size - run:	8 µF/400 V
Enclosure class (IEC 34-5):	IP68
Insulation class (IEC 85):	F
Length of power cable:	5 m
Type of cable plug:	AU
Others:	
Environmental approvals:	WEEE
Net weight:	6.5 kg
Gross weight:	7 kg
Shipping volume:	0.013 m ³
Country of origin:	DK
Custom tariff no.:	8413709019182742



Company name: ASC Water Tanks
Created by: Anant Yuvarajah
Phone: 0414880162
Email: anant@asc tanks.com.au
Date: 15/06/2022

011K4100 UNILIFT KP.150.M.1 50 Hz

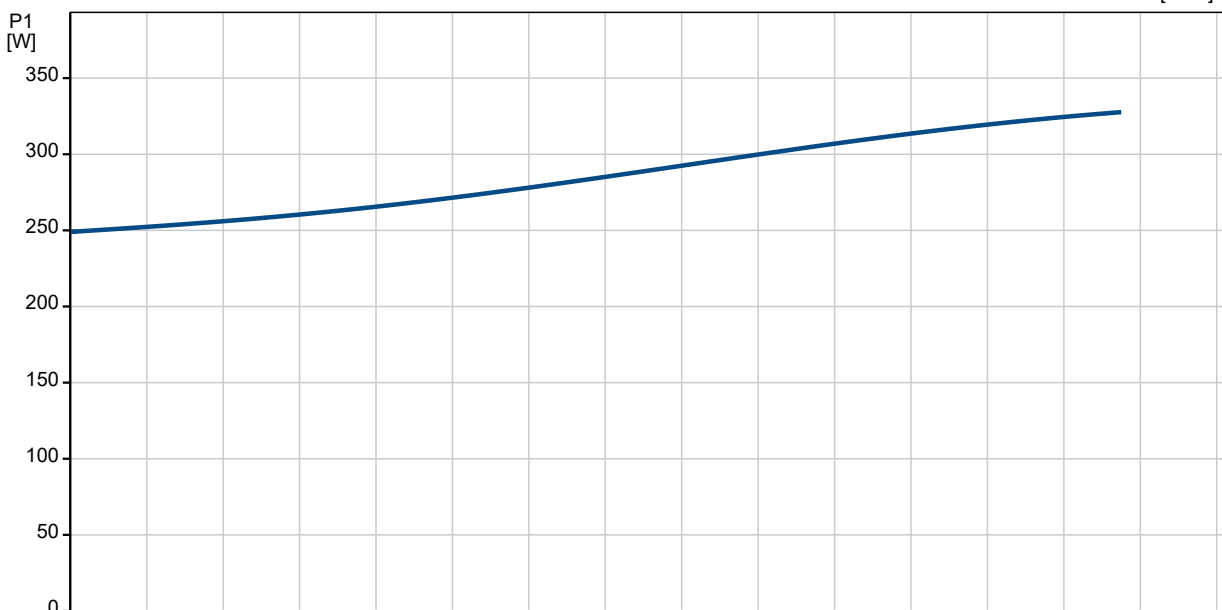
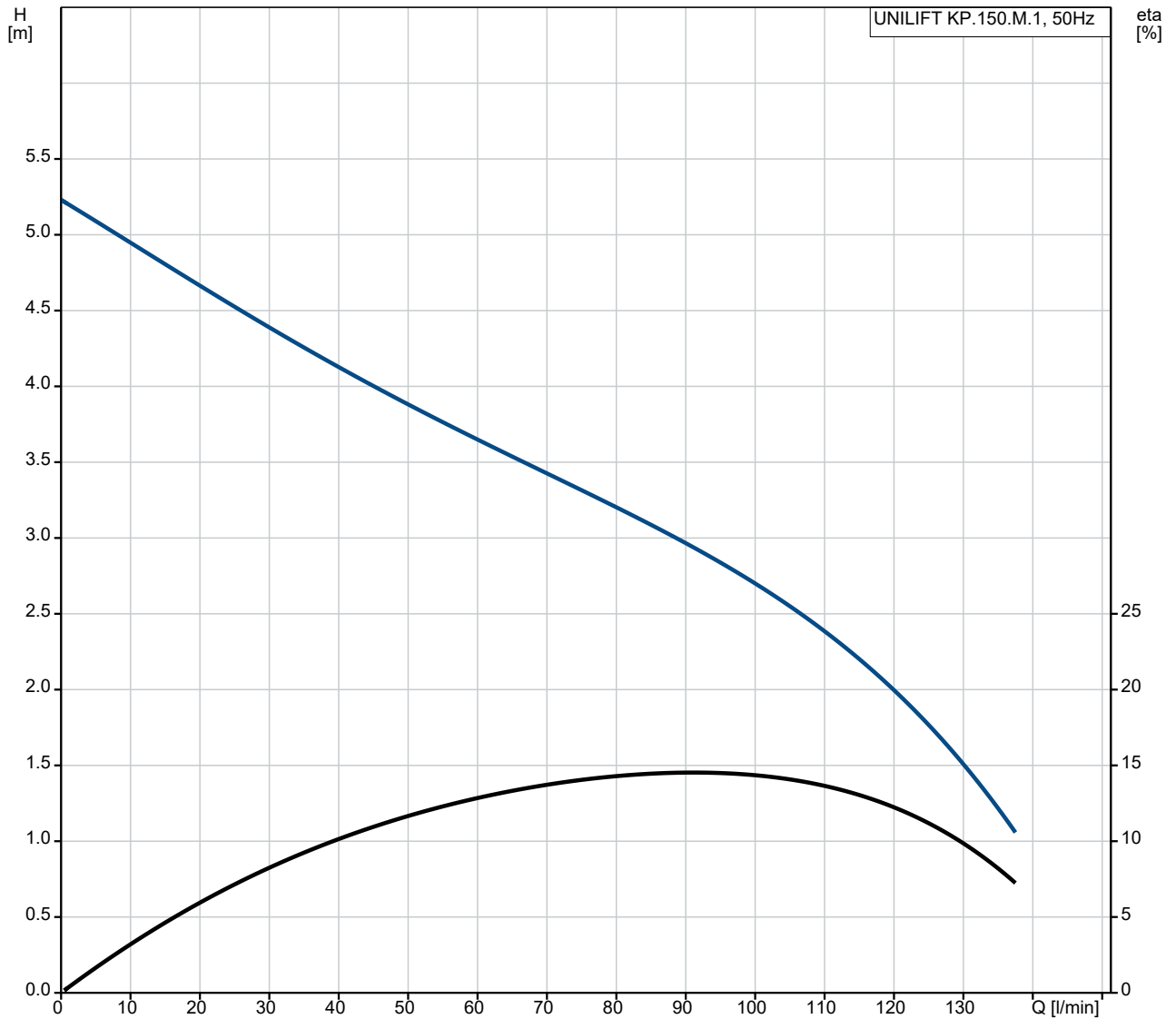



Company name: ASC Water Tanks
Created by: Anant Yuvarajah
Phone: 0414880162
Email: anant@asc tanks.com.au
Date: 15/06/2022

Description	Value
General information:	
Product name:	UNILIFT KP.150.M.1
Product No:	011K4100
EAN number:	5700391247774
Price:	
Technical:	
Maximum flow:	142 l/min
Maximum head:	5.5 m
Max. Particle:	10 mm
Approvals:	CE,RCM,LGABG,EAC,TUVRHWI D
Model:	A
Materials:	
Pump housing:	Stainless steel
Pump housing:	EN 1.4301
Pump housing:	AISI 304
Impeller:	Stainless steel
Impeller:	EN 1.4301
Impeller:	AISI 304
Installation:	
Range of ambient temperature:	0 .. 50 °C
Type of connection:	Rp
Size of connection:	1 1/4 inch
Maximum installation depth:	2 m
Liquid:	
Liquid temperature range:	0 .. 50 °C
Density:	998.2 kg/m ³
Electrical data:	
Power input - P1:	300 W
Mains frequency:	50 Hz
Rated voltage [V]:	1 x 230-240 V
Rated current:	1.3 A
Capacitor size - run:	8 µF/400 V
Enclosure class (IEC 34-5):	IP68
Insulation class (IEC 85):	F
Built-in motor protection:	CONTACT
Thermal protec:	internal
Length of power cable:	5 m
Type of cable plug:	AU
Others:	
Environmental approvals:	WEEE
Net weight:	6.5 kg
Gross weight:	7 kg
Shipping volume:	0.013 m ³
Country of origin:	DK
Custom tariff no.:	8413709019182742

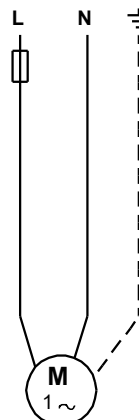
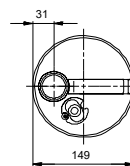
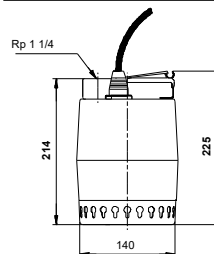
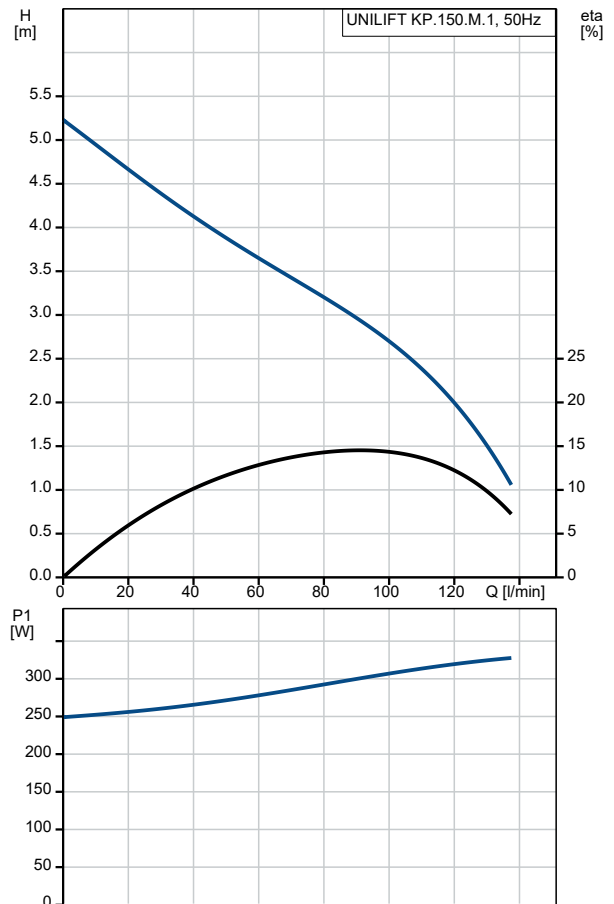



Company name: ASC Water Tanks
Created by: Anant Yuvarajah
Phone: 0414880162
Email: anant@asc tanks.com.au
Date: 15/06/2022

011K4100 UNILIFT KP.150.M.1 50 Hz

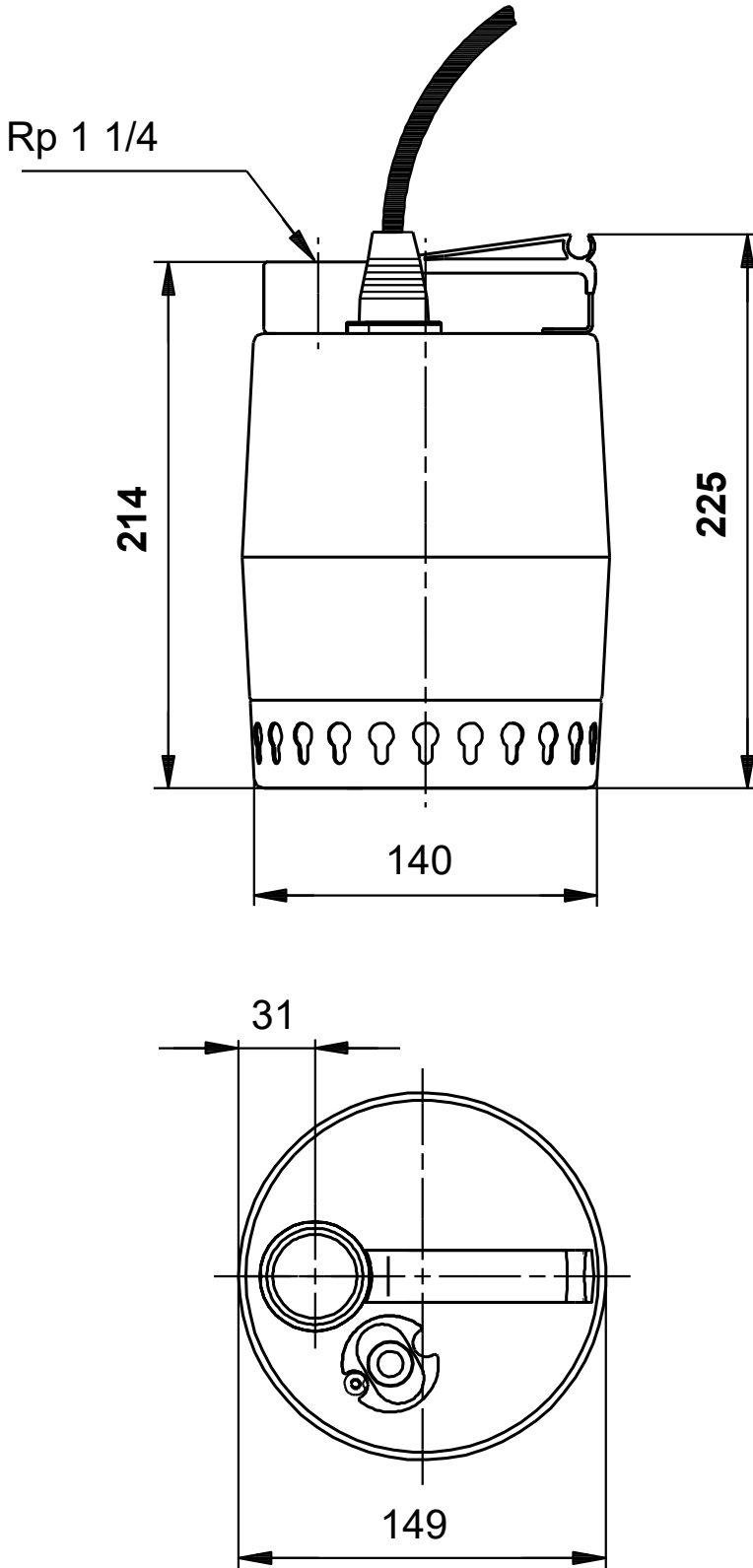

Note! All units are in [mm] unless others are stated.
Disclaimer: This simplified dimensional drawing does not show all details.