

microlene^o

AquaShield™ 2.0

Combined Domestic Water Filtration and Home Pressure System

Installation and Operating Instructions



Models:	AS20DD	AS20RB	CE
---------	--------	--------	----



ATTENTION: Please refer to daveywater.com for any product information updates, or simply scan this QR code.



Please pass these instructions on to the operator of this equipment.
READ AND SAVE THESE INSTRUCTIONS.

AquaShield™ 2.0

Congratulations on your purchase of a high quality, Davey AquaShield 2.0 combined domestic water filtration and home pressure system for use in providing filtered water at pressure to your home. All components have been designed and manufactured to give trouble free, reliable operation.

CONTENTS

Safety Considerations	3
1. Prior to installation you must ensure	5
2. Your new system	5
3. Applications and features	5
a. AquaShield 2.0 Dyna Drive – AS20DD	
b. AquaShield 2.0 RainBank – AS20RB	
4. Installation	6
a. Positioning / Site Selection	6
b. Pipe connections	7
c. Power connection	8
d. The pressure tank (AS20DD only)	9
5. Operation	9
6. Service & Maintenance	9
a. Periodic pressure test checks	
7. Davey Warranty	11
8. Operating Instructions for Installed Components	
a. Davey Microlene Centurion MCXS Operating Instructions	
i. AquaShield 2.0 Dyna Drive – AS20DD	
1. Davey DynaDrive Operating Instructions	
ii. AquaShield 2.0 RainBank – AS20RB	
1. Davey RainBank Operating Instructions	
2. Davey HM Series Operating Instructions	

Component Sections

1. Aquashield Centurion 3 Stage UV Disinfection System	▲
2. DynaDrive Constant Pressure System	▲
3. RainBank Automatic Water Controller	▲
4. HM Series Electric Pump	▲

Safety Considerations

1. Make sure the cover is closed and locked during normal use, only open the cover for servicing and maintenance.
2. Davey AquaShield 2.0 is not to be used by persons (including children) with reduced physical, sensory or mental capabilities, or lack of experience and knowledge, unless they have been given supervision or instruction concerning use of the appliance by a person responsible for their safety.
3. Children should be supervised to ensure that they do not play with the appliance

Although your UV system has been manufactured to the highest safety standards, care must be followed when operating and/or maintaining your system.

1. Before servicing this equipment, disconnect the power cord from the electrical outlet.
2. **Energy given off by the UV lamp is harmful to your eyes and skin.** NEVER look directly at an illuminated UV lamp without adequate eye protection and always protect your skin from direct exposure to the UV light.
3. For complete disinfection, use ONLY genuine replacement parts.
4. Do not operate the unit if it has any damaged or missing components.
5. To avoid possible electrical shock, use only with a properly grounded electrical outlet.
6. Never perform any maintenance to the system unless you are comfortable in doing so. Contact the manufacturer for service instructions if required.
7. Do not use this system for any purpose other than what it was intended for. Misuse of this system could potentially cause harm to the user or others.
8. Your system is intended to be installed indoors and away from leaking plumbing. DO NOT plug the unit in if the system or any of the components are wet.
9. The disinfection system should be directly installed into a ground fault circuit interrupter (GFCI). If the use of an extension cord is required, the cord must be manufactured with a minimum of 16 gauge wire and care should be taken to avoid potential tripping hazards.
10. We recommend that a licensed plumber or certified technician install the system.



CAUTION: This pump has been evaluated for use with water only. Do not insert any object in the opening. Before using this pump, the pump must be well installed. Children should be supervised that they do not play with the pump. NPT model variants acceptable for indoor use only, do not used outdoor. For use with maximum 80°C (176°F) water.

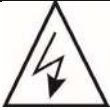

WARNING: Risk of electric shock. This pump is supplied with a grounding conductor and grounding-type attachment plug. To reduce the risk of electric shock, be certain that it is connected only to a properly grounded, grounding-type receptacle.

Nonsubmersible pump. This pump has not been investigated for use in swimming pool or marine areas. To reduce risk of electric shock, pull plug before servicing or cleaning this pump. Do not operate this pump with wet hands.



ATTENTION: The DynaDrive system and associated pipework operate under pressure. Under no circumstances should the DynaDrive system, or associated pipework be disassembled unless the internal pressure of the system has been relieved.

Failure to observe this warning will expose persons to the possibility of personal injury and may also result in damage to the pump, pipework or other property.

This appliance is not intended for use by persons (including children) with reduced physical, sensory or mental capabilities, or lack of experience and knowledge, unless they have been given supervision or instruction concerning use of the appliance by a person responsible for their safety. Children should be supervised to ensure that they do not play with the appliance. This appliance can be used by children from aged 8 years and above and persons with reduced physical sensory, mental capabilities, or lack of experience and knowledge if they have been given supervision, or instruction concerning use of the appliance in a safe way and understand the hazards involved.

Maximum pressure limited to 64m (210 feet) total head.

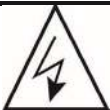

IMPORTANT: If the supply cord is damaged, it must be replaced by the manufacturer, its service agent, or similarly qualified persons in order to avoid a hazard. Pump is to be supplied through a residual current device (RCD) having a rated residual operating current not exceeding 30mA. Cleaning and user maintenance shall not be made by children without supervision. Children shall not play with the appliance.

Prior to installation remove the inlet and outlet pipe transport plugs & associated seals from the suction and/or discharge ports.

1. PRIOR TO USING THIS PRESSURE SYSTEM, YOU MUST ENSURE THAT

- The pump is installed in a safe and dry environment
- The pump enclosure has adequate drainage in the event of leakage
- Any transport plugs are removed
- The pipework is correctly sealed and supported
- The pump is primed correctly
- The power supply is correctly connected
- All steps have been taken for safe operation

Appropriate details for all these items are contained in the following Installation and Operating Instructions. Read these in their entirety before switching on this pump. If you are uncertain as to any of these Installation and Operating Instructions, please contact your Davey dealer, or the appropriate Davey office as listed on the back of this document.

2. Your new system

Congratulations on the purchase of your new Davey AquaShield 2.0.

The Davey AquaShield 2.0 combines the best of Davey's innovation and technology to provide pressurised, filtered water for domestic or small industrial application.

Depending on the model of Davey AquaShield 2.0 you have purchased your unit is designed as a plug and play solution and it is recommended that it is installed by a licensed plumber or certified technician.

3. Applications and features

As the AquaShield 2.0 is a combination of Davey's best filtration and pressure products this Installation & Operating Instruction provides a summary of the generic installation requirements for the main unit and following is the specific Installation & Operating Instructions for the individual components that make up the complete unit.

Both versions of the AquaShield 2.0 incorporate the Davey Microlene Centurion MCXS 3 stage water filtration and sterilisation system.

AS20DD – Incorporates the Davey DynaDrive home pressure system designed for application with access to stored water sources such as rain water also referred to as “off grid” application.

AS20RB – Designed for application where there is access to mains or “town” water allowing for stored water to act as the primary water source, reducing the

reliance/cost on mains water. This incorporates the Davey HM60-08 Pressure pump and Davey RainBank to automatically identifies when tank water is not available and switches to mains supply until sufficient stored water is available again to switch back over.

4. Installation

The Davey AquaShield 2.0 is designed to simple to install although Davey always recommends that it be installed by a licensed plumber or certified technician.

1. Information regarding installation, details to keep the unit out of the weather and fixing to a support surface.

Only AquaShield 2.0 with RainBank should be connected to mains water through the RainBank it is important to ensure local regulations are adhered to and that in most instances a backflow prevention valve is installed between the meter and AquaShield 2.0 to ensure that there is no risk to non-treated water making ingress into the mains supply.

AquaShield 2.0 with DynaDrive is not recommended for direct connection to mains water supplies. In most cases an isolating tank is required between mains supply and pump, please see page 4 of the DynaDrive Installation and Operating Instructions. Davey also recommend this method. Directly applied mains pressure can exceed pump operating pressure and damage pump. Davey Water Products Pty Ltd cannot accept responsibility for loss, or damage resulting from incorrect, or unauthorized installations.

4a. Positioning

Choose a clean and dry site with a firm base as close to the water source as possible with correct power supply. Make sure your AquaShield 2.0 is always connected to an adequate, reliable source of clean water. To protect your AquaShield 2.0 from the weather, make sure the enclosure is installed on the side of the house with protection from weather and sun, frost free and has adequate ventilation. The unit should be mounted on a firm base allowing for drainage, to avoid damage to flooring etc., that over time may occur from leaking pipe joints or pump seals. Do not mount the unit vertically. Never place flammable materials on, or near the unit.

The Davey AquaShield 2.0 houses a UV chamber that uses UV light to sterilise bacteria that may exist in water, the UV light remains on at all times and generates heat when not in use. The AquaShield 2.0 is fitted with an extraction fan and temperature switch to use ambient air to cool the housing should the temperature exceed 35°C and returns the environment to 25°C or lower.

It is recommended that the AquaShield 2.0 be positioned where it is least exposed to direct sunlight and the recommended position for the unit is

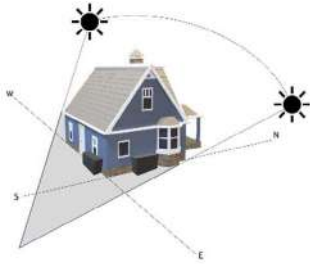

Southern Hemisphere

- Preferred - South side of the house with minimal exposure to sunlight;
- Alternative – Eastern side of the house minimising exposure to morning sunlight.

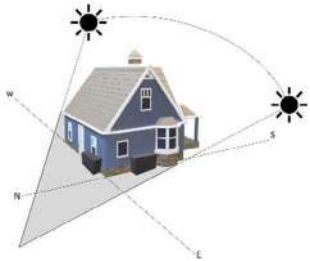

Northern Hemisphere

- Preferred - North side of the house with minimal exposure to sunlight;
- Alternative – Eastern side of the house minimising exposure to morning sunlight.

4b. Pipe connections

For best performance use P.V.C. or polythene pipe with a diameter at least the same as the units inlet which is 32mm BSP. Larger diameter pipe may be used to minimise resistance to flow when pumping for distances longer than 5m (16'). Use unions at pipe connections to enable easy removal and servicing. Use enough "plumbers' tape" to ensure airtight seal and hand tighten only, do not screw connections all the way into suction port. To prevent strain on pump thread always support heavy inlet and outlet pipes.

RainBank Maximum Inlet Pressure: Ensure that maximum inlet pressure to the RainBank unit does not exceed 600kpa (87psi).

Lay suction pipe at a constant gradient to avoid air pockets which may reduce pump efficiency. Avoid installing 90° elbows before the suction inlet of the unit, within a distance equivalent to 5 x pipe diameter. For example: using 40mm (1½") suction pipe, avoid installing a 90° elbow within 200mm (7¾") of the pump inlet. This will assist laminar flow.

Connect outlet to house supply through standard plumbing installation, outlet thread is 25mm BSP

4c. Power connection

AquaShield 2.0 is designed to run off mains power. The standard plug is rated to fit a 240V mains outlet with a 10amp earth plug.

IMPORTANT: Long extension leads should be avoided as they often have insufficient current carrying capacity to run electric motors, hence they can cause substantial voltage drop and operating problems.

If the electrical fittings in your country make it necessary to remove the plug from the lead fixed to the motor care should be taken to ensure that the earth conductor green/yellow in the lead is properly connected to a good earth.

ATTENTION: Ensure that any and all electrical work is only undertaken by an authorized electrician. Before obtaining access to terminals, all supply circuits must be disconnected.

The electrical connections and checks must be made by a qualified electrician and comply with applicable local standards. Poor installation, or poor power supply may even result in electrical fires!

ATTENTION: Automatic reset thermal overloads will allow the pump to restart without warning. ALWAYS disconnect the pump motor from the electrical supply before maintenance or repairs.

NOTE:

- Ensure motor is connected to power supply specified on nameplate;
- Although the Davey electric motor is specifically engineered to perform on a range of power supply voltages, malfunctions or failure caused by adverse voltage supply conditions are not covered under guarantee.

ATTENTION: We are obliged to inform you that this pump is not to be used by children, or infirm persons and must not be used as a toy by children. Some insects such as small ants, find electrical devices attractive for various reasons. If your pump enclosure is susceptible to insect infestation you should implement a suitable pest control plan.

4d. The pressure tank (AS20DD only)

If air charge adjustment is required, then follow these procedures:

- Remove the pressure tank completely from pump installation, ensuring to isolate the pressure tank and release the water pressure from the tank beforehand; or
- Release all water pressure from the pressure tank by switching off the pump at the power point and opening the closet tap. For above ground supply tanks, it is necessary to close the gate valve between the supply tank and the pump;

ATTENTION: To prevent personal injury, ensure all water pressure is released from the pressure system prior to work being performed.

- Leave tap open during air replenishment;
- When all water pressure has been released from the system, check air pressure at air valve on top of pressure tank. The pre-charge pressure reading should be 70% of set point pressure;
- If necessary, replenish air charge to the correct pressure indicated. Ensure that a tap in outlet piping of pump is open during replenishment of air pre-charge.

5. Operation

Davey AquaShield 2.0 is designed as a plug and play water pressure and treatment unit for domestic and light industrial application. Once installed the unit will operate automatically based on water demand providing pressure and flow based on the opening of a tap or valve indicating the use of water.

For individual setting and usage of components housed within the AquaShield 2.0 please refer to the installation and operating instructions for the specific component that for a part of the complete installation and operating instructions.

6. Servicing and Maintenance

4.1 3 Stage Filtration

In order to ensure the optimal performance and quality of water being filtered by the AquaShield 2.0 it is recommended that the following schedule be adhered to as part of a minimum standard for the health and safety of those consuming water provided by this unit.

Stage 1 Filter (Replacement 20PP20J)

- Wash if experiencing pressure drop or every 3 months
- Replace filter every 12 months

Stage 2 Filter (Replacement 1PS20J)

- Replace every 6 months

UV Lamp (Replacement MC-HOLP)

- Replace every 14 months

UV Quartz Sleeve (Replacement MC-HOSL)

- Clean a least every 14 months dependant on water quality

ATTENTION: Automatic resets may allow the pump to restart without warning. Always disconnect the pump motor from the electrical supply before maintenance or repairs. When servicing or attending pump and/or controllers, always ensure power is switched off and lead unplugged. Electrical connections should be serviced only by qualified persons. If the electrical supply lead of this pressure system is damaged, it must be replaced by the manufacturer, or an appointed representative. Under no circumstances should the DynaDrive be disassembled by other than qualified tradespersons. Failure to observe this warning may expose persons to the possibility of personal injury and may also result in damage to other property. Do not dismantle spring under pressure.

IMPORTANT: Do not use hydrocarbon based or hydrocarbon propelled sprays around the electrical components of this pump. During servicing, use only approved, nonpetrochemical based o-ring and gasket lubrication. If unsure, consult your Davey representative for advice. For protection, DynaDrive monitors input current and will shut down the pump motor in the event of an over load.

4.2 Periodic pressure tank checks

Depending on the quality of the pumped water, from time to time your tank may require flushing to remove settled fines such as mud or sand. If sand, or mud can stay in the tank it will accelerate wear on the internal lining and shorten your tanks life. Safely disconnect the tank from the water supply, discharge all air from the tank and flush the tank several times with clean water. Once the flushing water is clean, reconnect the tank and recharge the air as described in the pressure tank section of the installation chapter.

A tank in good order will not leak, but over time due to damage through rough handling, impacts or grit and/or impurities in the water the tank shell may fail and/or leak. Should the tank leak or show signs of possible failure the tank should be immediately disconnected and replaced.

Davey Warranty

Davey Water Products Pty Ltd (Davey) warrants all products sold will be (under normal use and service) free of defects in material and workmanship for a minimum period of one (1) year from the date of original purchase by the customer as marked on the invoice, for specific warranty periods for all Davey products visit daveywater.com.

This warranty does not cover normal wear and tear or apply to a product that has:

- been subject to misuse, neglect, negligence, damage or accident
- been used, operated or maintained other than in accordance with Davey's instructions
- not been installed in accordance with the Installation Instructions or by suitably qualified personnel
- been modified or altered from original specifications or in any way not approved by Davey
- had repairs attempted or made by other than Davey or its authorised dealers
- been subject to abnormal conditions such as incorrect voltage supply, lightning or high voltage spikes, or damages from electrolytic action, cavitation, sand, corrosive, saline or abrasive liquids,

The Davey warranty does not cover replacement of any product consumables or defects in products and components that have been supplied to Davey by third parties (however Davey will provide reasonable assistance to obtain the benefit of any third-party warranty).

To make a warranty claim:

- If the product is suspected of being defective, stop using it and contact the original place of purchase. Alternatively, phone Davey Customer Service or send a letter to Davey as per the contact details below
- Provide evidence or proof of date of original purchase
- If requested, return the product and/or provide further information with respect to the claim. Returning the product to the place of purchase is at your cost and is your responsibility.
- The warranty claim will be assessed by Davey on the basis of their product knowledge and reasonable judgement and will be accepted if:
 - a relevant defect is found
 - the warranty claim is made during the relevant warranty period; and
 - none of the excluded conditions listed above apply
- The customer will be notified of the warranty decision in writing and if found to be invalid the customer must organise collection of the product at their expense or authorise its disposal.

If the claim is found to be valid Davey will, at its option, repair or replace the product free of charge.

The Davey warranty is in addition to rights provided by local consumer law. You are entitled to a replacement or refund for a major failure and compensation for any other reasonably foreseeable loss or damage. You are also entitled to have the goods repaired or replaced if the goods fail to be of acceptable quality and the failure does not amount to a major failure.

For any internet connected products the consumer is responsible for ensuring a stable internet connection. In the event of a network failure the consumer will need to address the concern with the service provider. Use of an App is not a substitute for the User's own vigilance in ensuring the product is working to expectation. Use of a Smart Product App is at the User's own risk. To the fullest extent permitted by law Davey disclaims any warranties regarding the accuracy, completeness or reliability of App data. Davey is not responsible for any direct or indirect loss, damage or costs to the User arising from its reliance on internet connectivity. The User indemnifies Davey against any claims or legal actions from them or others relying on internet connectivity or App data may bring in this regard.

Products presented for repair may be replaced by refurbished products of the same type rather than being repaired. Refurbished parts may be used to repair the products. The repair of your products may result in the loss of any user-generated data. Please ensure that you have made a copy of any data saved on your products.

To the fullest extent permitted by law or statute, Davey shall not be liable for any loss of profits or any consequential, indirect or special loss, damage or injury of any kind whatsoever arising directly or indirectly from Davey products. This limitation does not apply to any liability of Davey for failure to comply with a consumer guarantee applicable to your Davey product under local laws and does not affect any rights or remedies that may be available to you under local laws.

For a complete list of Davey Dealers visit our website (daveywater.com) or call:

DAVEY

Davey Water Products Pty Ltd
Member of the GUD Group
ABN 18 066 327 517

daveywater.com

AUSTRALIA

Head Office
6 Lakeview Drive,
Scoresby, Australia 3179
Ph: 1300 232 839
Fax: 1300 369 119
Email: sales@davey.com.au

NEW ZEALAND

7 Rockridge Avenue,
Penrose, Auckland 1061
Ph: 0800 654 333
Fax: 0800 654 334
Email: sales@dwp.co.nz

EUROPE

7 rue Eugène Hénaff 69200
Vénissieux, France
Ph: +33 (0) 4 72 13 95 07
Fax: +33 (0) 4 72 33 64 57
Email: info@daveyeurope.eu

NORTH AMERICA

Ph: 1-888-755-8654
Email: info@daveyusa.com

MIDDLE EAST

Ph: +971 50 6368764
Fax: +971 6 5730472
Email: info@daveyuae.com

DAVEY

Davey Water Products Pty Ltd
Member of the GUD Group
ABN 18 066 327 517

daveywater.com

AUSTRALIA

Head Office

6 Lakeview Drive,
Scoresby, Australia 3179
Ph: 1300 232 839
Fax: 1300 369 119
Email: sales@davey.com.au

NEW ZEALAND

7 Rockridge Avenue,
Penrose, Auckland 1061
Ph: 0800 654 333
Fax: 0800 654 334
Email: sales@dwp.co.nz

EUROPE

7 rue Eugène Hénaff 69200
Vénissieux, France
Ph: +33 (0) 4 72 13 95 07
Fax: +33 (0) 4 72 33 64 57
Email: info@daveyeurope.eu

NORTH AMERICA

Ph: 1-888-755-8654
Email: info@daveyusa.com

MIDDLE EAST

Ph: +971 50 6368764
Fax: +971 6 5730472
Email: info@daveyuae.com

DAVEY

microlene[®]

Aquashield Centurion 3 Stage UV Disinfection System

Models: MCS & MCXS (without cartridges)
KMCS & KMCXS (with cartridges included)

Installation and Operating Instructions



Flow Rate (30mJ/cm ² @ 95% UVT)	57 L/min
---	----------



Please pass these instructions on to the operator of this equipment.



Aquashield Centurion 3 Stage UV Disinfection System

Congratulations on purchasing this ultraviolet disinfection system. By purchasing a Davey Microlene UV Disinfection system you are receiving not only a high quality product but also peace of mind. Protecting your water supply with a UV system gives you reassurance that your family will have access to safe drinking water throughout your entire home protecting from microbiological contamination. This is a chemical free process which is simple in its concept and effective in its abilities to inactivate microorganisms present in the water supply.

- Simple maintenance
- Continuous disinfection
- Safe water

Microlene makes it that easy.

These instructions are also available in soft copy via email from Microlene Customer Service, or by downloading at daveywater.com.

Contents

Safety Considerations	4
Before You Begin	4
Water Quality Parameters	5
Assembly	6
System Sizing	7
Location	7
Orientation	8
Installation	9
System Disinfection	12
Cleaning the Quartz Sleeve	12
Cleaning the UV Sensor	13
Operation	13
MCS Controllers	14
MCXS Controllers	14
MCXS Power-up Sequence	14
MCXS Operational Screens	15
MCXS (with optional sensor) Operational Screens	16
Lamp Countdown Sequence	16
Lamp Replacement (MCS systems)	17
Lamp Replacement (MCXS systems)	17
QR Codes	17
System Troubleshooting	18
Temperature Management Devices	19
Expansion Modules	20
Microlene Aquashield Centurion UV System Specifications	21
Limited Warranty Statement	22

Safety Considerations

Although your UV system has been manufactured to the highest safety standards, care must be followed when operating and/or maintaining your system.

1.  Please read the instructions.

- This appliance contains a UV-C emitter.
- Unintended use of the appliance or damage to the housing may result in the escape of dangerous UV-C radiation. UV-C radiation may, even in little doses, cause harm to the eyes and skin.
- The appliance must be disconnected from the supply before replacing the UV-C emitter.
- The appliance is intended to be permanently connected to the water mains and not connected by a hose-set.

2. Before servicing this equipment, disconnect the power cord from the electrical outlet.



WARNING: Do not operate the UV-C emitter when it is removed from the appliance enclosure.

3. **Energy given off by the UV lamp is harmful to your eyes and skin.** NEVER look directly at an illuminated UV lamp without adequate eye protection and always protect your skin from direct exposure to the UV light.
4. For complete disinfection, use ONLY genuine replacement parts.
5. The appliance is not to be used by persons (including children) with reduced physical, sensory or mental capabilities, or lack of experience and knowledge, unless they have been given supervision or instruction.
6. Children should be supervised so that they do not play with the appliance.
7. To avoid possible electrical shock, use only with a properly earthed electrical outlet. Appliances that are obviously damaged must not be operated.
8. Never perform any maintenance to the system unless you are comfortable in doing so. Contact the manufacturer for service instructions if required. Read the maintenance instructions before opening the appliance.
9. Do not use this system for any purpose other than what it was intended for. Misuse of this system could potentially cause harm to the user or others.
10. Your system is intended to be installed indoors and away from leaking plumbing. DO NOT plug the unit in if the system or any of the components are wet.
The UV system should only be installed outdoors if a suitable covering has been installed to prevent direct contact with the environment (Rain and/or direct sunshine).
11. The appliance is to be supplied through a residual current device (RCD) having a rated residual operating current not exceeding 30mA.
12. Maximum working voltage of built-in UV driver U-OUT-250V
13. Maximum operating pressure stated in the instruction manual is 827 kPa (120 psi).
14. We recommend that a licensed plumber or certified technician install the system.

15. An electrical power surge or spike can travel on the supply lines and cause serious damage to your electrical equipment. If the installation is susceptible to electrical power surges, or lightning, we strongly recommend the use of a suitable surge protection device on ALL electrical equipment.
16. To protect your UV system from the weather, make sure the site is water proof, frost free and has adequate ventilation. Allow for drainage, to avoid damage to flooring etc., that over time may occur from leaking pipe joints or seals.
17. If the supply cord is damaged, it must be replaced by the manufacturer, its service agent or similarly qualified persons in order to avoid a hazard.



This product is not to be used for general lighting / illumination.

Before You Begin

The following will be needed for installing the UV system:

Tools

- Pipe cutter, hacksaw or other specialized tools required to cut into your existing plumbing (e.g. if you have PEX piping)
- Soldering tools (torch, flux, emery cloth and solder as required - depending on plumbing.)
- Wrench (for tightening fittings)

Other Materials

- Inlet/outlet connections
- Teflon™ thread tape

Water Quality Parameters

UV disinfection is extremely effective against microorganisms but only if the UV light can pass through the water it needs to treat. This means that the quality of your water is very important in order to ensure complete disinfection.

Treated water should be tested for at least the parameters listed below. If the water exceeds the listed parameters Davey strongly recommends that appropriate pretreatment equipment be installed (equipment required will depend on parameters being treated):

Hardness: <120mg/L (7gpgUS) – if hardness level is 120mg/L (7 gpg) or slightly below the quartz sleeve must be cleaned periodically in order to ensure efficient UV penetration; if above the water must be softened.

Iron (Fe): <0.3 ppm (0.3 mg/L)

Manganese (Mn): <0.05 ppm (0.05 mg/L)

Turbidity: < 1 NTU

Tannins (organics): <0.1 ppm (0.1 mg/L)

UVT (transmittance): 85% (Please contact Davey if water has a UVT that is less than 80% for pre-treatment recommendations)

You can have your water tested via your local dealer or a private analytical laboratory. It is always recommended to install pre-filtration of at least 5 microns (1 micron preferred for Cyst removal on Rain Water) prior to a Microlene Aquashield Centurion UV disinfection system.

Assembly

The Microlene Aquashield Centurion 3 Stage UV disinfection system is designed with a single inlet and outlet port. Unpack the system and ensure all the components are included in the box. Your system is shipped with the following components:

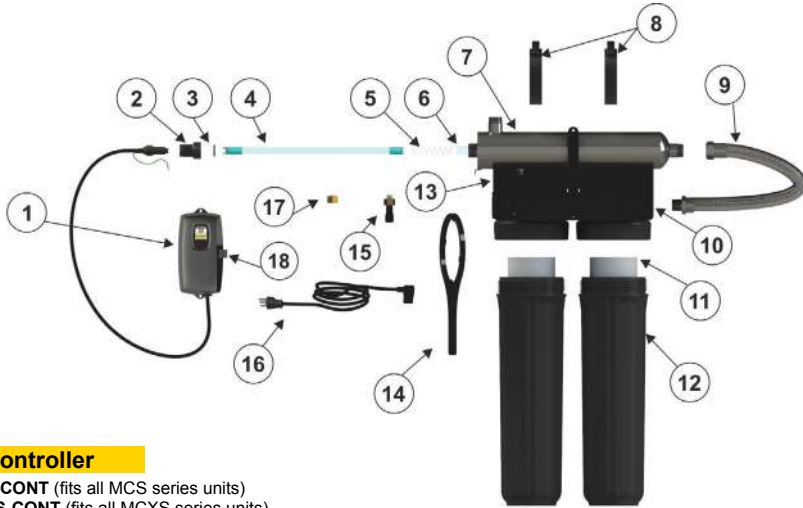

1 Controller

MCS-CONT (fits all MCS series units)
MCXS-CONT (fits all MCXS series units)

2 Gland Nut

Part # DM320006

3 O-ring

Part # DM300038

4 UV Lamp

Part # MC-HOLP

5 Sleeve Spring

Part # DM310039

6 Quartz Sleeve

Part # MC-HOSL

7 UV Chamber

8 Clamps

9 Flexible Hose

10 Mounting Plate

11 Filter Cartridges

(Only KMCS and KMCXS have filters included)

Part # 20PP20J (20", 20 micron sediment)
Part # 1PS20J (20", 1 micron sediment)

12 Filter Housings

Part # DM160018 (double filter housing, two 20" sumps and caps)

13 Mounting Screws

14 Filter Wrench

Part # WFH45

15 UV Sensor

(optional module)

Part # MCXS-UVS

16 IEC Power Cable

Part # MC-CONT-PC Australian, AS/NZS 3112, 3 pin earthed

17 Glow Plug Assembly

(on MCXS /KMCXS units only)

DM300016 Complete Assembly includes Teflon Plug, O-Ring, Brass Nut

18 Lamp Key

Comes with new UV lamps (NOT sold separately) (not for use on the MCS which has the MCS-CONT controller)

Location

Choose a location where the main cold water line is accessible. The system must be installed after other water treatment equipment (i.e. softener), but before any branches (See Figure 1).

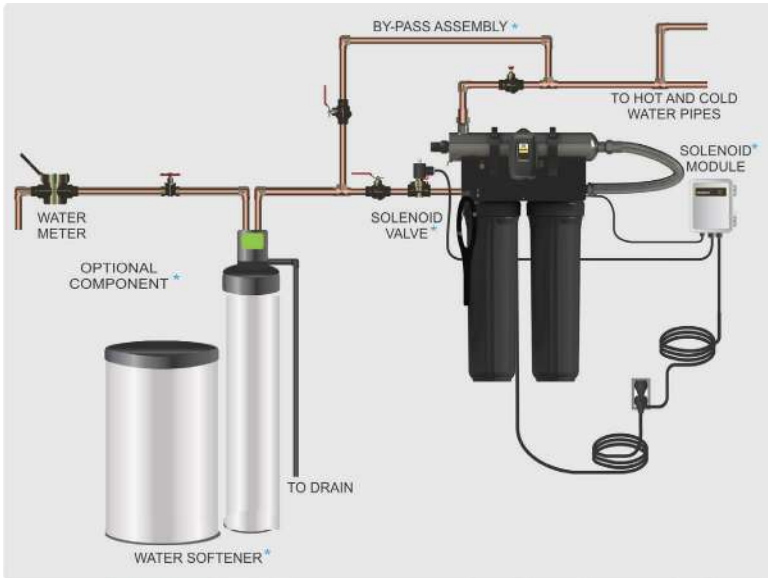

Figure 1. Typical Installation

To facilitate lamp removal, ensure there is enough space at the lamp connector end to safely remove the UV lamp and/or quartz sleeve (See Installation Figure 3). The controller will require a Residual Current Device (RCD) outlet and should be mounted beside or above the chamber.



IMPORTANT:

All Microlene Aquashield Centurion UV Disinfection Systems are intended to be installed under a weather proof cover and should not be exposed to the elements.

MCS-C Weather proof cover (purchased separately)

- Protects the chamber and controller from rain and direct elements
- Enables the 3 Stage UV system to be set up left to right or right to left for ease of installation.
- Mounting holes are aligned with the UV System
- Insert locking pin or screwdriver to cover open during servicing
- Lamp change through side of the holes, no disassembling required
- Made from: 1.2mm titanium laminate zintek®
- Powdercoated with matt satin black finish



Orientation

This system has the ambidextrous capability of being able to have the main water inlet enter from either the left hand side or right hand side of the unit. The unit comes pre plumbed from the factory for a left hand water inlet.

To change to a right hand water inlet follow these simple steps (See Figure 2):

Step 1: Remove the two black filter sump housings from the filter head and set aside.

Step 2: Remove the filter head screws from the top mounting plate.

Step 3: Carefully lower the filter head (or heads) from the rack assembly and rotate 180 degrees. Reassemble onto the rack assembly and take note of the arrows located on the top of the filter heads indicating water flow (which now should be indicating a flow direction of right-to-left).



Figure 2. System Orientation (water inlet)

Step 4: Remove the stainless steel UV chamber from the two plastic clamps located on the top of the rack. Carefully remove the top straps securing the chamber with the aid of a standard (slot) screwdriver. Rotate the chamber 180 degrees (with the inlet now facing to the left and the lamp connections located towards the right) and place back into the cell clamps and re affix the two top straps.

In either the left or right configurations, to facilitate lamp removal, ensure there is enough space at the lamp connector end to safely remove the UV lamp and/or quartz sleeve (See Figure 3).



IMPORTANT:

All Microlene Aquashield Centurion UV Disinfection Systems are intended to be installed under a weather proof cover and should not be exposed to the elements.

Installation

Step 1: Once both the orientation and location have been selected, securely fasten the rack to a suitable backing. As the rack system is extremely heavy when filled with water, it is imperative that the rack be mounted with suitable fasteners for the particular installation. Mounting to a plasterboard backing is not suitable, unless the rack is fastened directly to the wall studs.

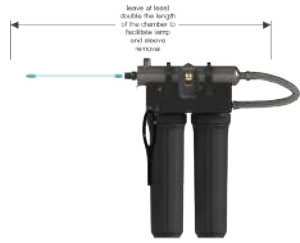

Figure 3. Lamp Removal Spacing

Step 2: The use of a bypass assembly is recommended as it will allow you to isolate the UV system. This will allow for easier access in case maintenance is required.

Step 3: For water supplies where the maximum flow rate is unknown, a flow restrictor is recommended so that the rated flow of your particular Microlene system is not exceeded. The flow restrictor should be installed on the inlet port of the chamber.

Step 4: It is recommended to have a licensed plumber connect the UV chamber to the water supply and may be a requirement depending on where you are located.

Step 5: Connect both the inlet and outlet to the rack system with the applicable connections based on your particular plumbing requirements. The inlet port of the filter housing is a 1" FNPT connection and the outlet port of the UV chamber is a 1" MNPT connection.

These NPT threads will connect to the same size BSP threads on plastic pipe fittings, alternatively NPT to BSP adapters from your local plumbing store can be used.

Step 6: Once the system has been plumbed in, gently remove the quartz sleeve from its packaging being careful not to touch the sleeve or lamp with your hands. The use of cotton gloves is recommended for this procedure as oils from the hands can leave residue on the sleeve and lamp which can ultimately block the UV light from getting to the water.



Figure 4. Quartz Sleeve Installation

Carefully slide the sleeve into the chamber until you can feel it hit the opposite end of the chamber. Align the sleeve so it is centered along the length of the chamber, then gently push it in to lock it into the internal centering springs in the far side of the chamber. **CAUTION:** Pushing too hard when the sleeve is not aligned can damage the centering springs. Slide the o-ring onto the sleeve until it is butted up against the chamber (See Figure 4).

Step 7: Hand tighten the provided gland nut over the quartz sleeve onto the threaded end of the chamber. It has a positive stop to prevent over tightening. A firm force may be required to fully tighten the gland nut, but **DO NOT USE TOOLS** for this step. Insert the provided stainless steel compression spring into the quartz sleeve. The spring works with the lamp and lamp connector to create the proper lamp alignment. **PLEASE NOTE:** DO NOT install a UV lamp inside the quartz sleeve without the sleeve spring in place.

Step 8: Install the filter cartridges in their appropriate housings. Refer to the specification chart in the datasheet or this instruction manual. **PLEASE NOTE:** This chart indicates the correct cartridge position for the default "left-hand" orientation with the water inlet located on the left side of the

rack system. If the orientation was switched, the cartridge placement must also be switched. Once the cartridges are in place, use the supplied filter wrench to “snug” the filter housing onto the filter head (See Figure 5).

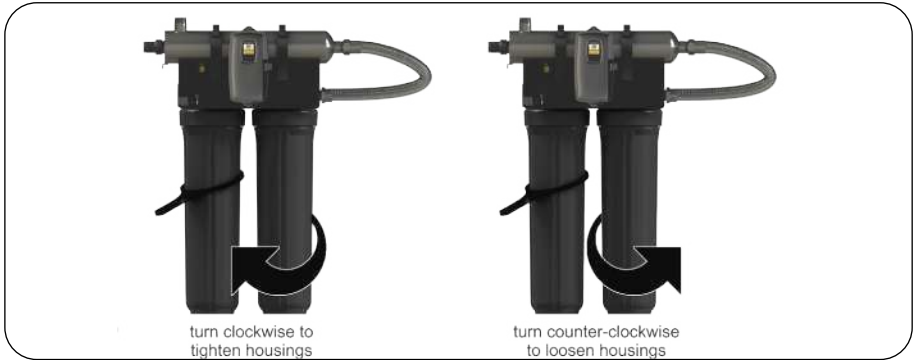

Figure 5. Cartridge Removal

Step 9: Install the UV sensor (**optional and only compatible with the MCXS system, not compatible on the MCS standard controller**). Align the flat portion so it faces the gland nut end and matches up with the half metal lip on the sensor port (see Figure 6). Insert the sensor so it is fully seated and hand tighten the sensor nut. Insert the sensor connector into the IEP port located on the right side of the controller (Figure 7). For the sensor to be recognized by the controller, the controller power must be plugged in last. **Do not plug the controller power cord in before the last step.**



Figure 6. UV Sensor Installation



Figure 7. IEP Connection



Figure 8. High Output UV Lamp Connection

Step 10: Install the lamp key into the controller (MCXS/KMCXS systems only). The key always comes packaged with the lamp and sits on the connector. With the key removed from the lamp, orient it so the label is upright and facing you. The key will plug into the lamp key port on the right side of the controller (Figure 8).

Note: All replacement lamps will come with a key. If you have the MCS controller, the key should be discarded as it can't be used in the MCS controller.

Step 11: Plug the lamp connector into the lamp. Note the keying for proper alignment (see Figure 8). Insert the lamp connector into the gland nut and turn the connector approximately $\frac{1}{4}$ turn to lock the connector to the gland nut as in Figure 10.



Figure 9. Lamp Key Installation



Figure 10. Lamp Connector

Step 12: Tighten the captive earth screw to the earth lug on the UV chamber to ensure proper earthing.



Figure 11. Earth Screw Connection

Step 13: Your system is now ready to be plugged into the appropriate residual current device (RCD) protected outlet. Refer to the following section before any water is allowed to flow through the system.



Note: Installation of your Microlene disinfection systems must comply with applicable provincial/state & local regulations.

System Disinfection

With a new installation, or any time the UV system is shut down for service, without power, or is inoperative for any other reason, the lines in the home or facility could be contaminated. Use the following steps to fully disinfect the lines throughout the entire home or facility.

For Rainwater tanks, add Acquasafe to your tank water supply and maintain the required result on test strips for the first month at least. This will clean your pipe lines downstream without water wastage. Acquasafe can be used at the same time as UV and is another protection against pathogens.

For other water sources or where the plumbing maybe suspected of having contamination the use of stronger chemical flushing maybe needed.

- Step 1:** Check for and remove any “dead ends” in the lines throughout the home as these can harbour bacteria. Plug in the UV system and wait until it is ready for operation.
- Step 2:** Remove the filter cartridge from the last sump and fill it with the applicable volume of plumbing sanitiser or 1-2 cups of household bleach (most are 5.25% chlorine). Replace the sump and slowly turn on the water supply.
- Step 3:** At a water outlet, run the water until bleach can be smelled. Repeat this for all faucets, toilets, shower heads, refrigerators, outdoor taps, the washing machine, dishwasher, etc. at the home or facility. Once finished, wait a minimum of 30 minutes before continuing.
- Step 4:** Reinstall the filter cartridge into the sump and flush the chlorine solution by opening all faucets until chlorine can no longer be detected. Your home has now been completely disinfected with your Microlene Aquashield Centurion UV system ready to inactivate any microorganisms that enter the home.

Cleaning the Quartz Sleeve

Depending on the water quality, the quartz sleeve may require periodic cleaning. At a minimum, the quartz sleeve should be cleaned on an annual basis. The following steps outline a basic cleaning procedure.

- Step 1:** If a by-pass assembly is installed, shut the inlet valve off to prevent water flow through the system. Otherwise, turn off main water inlet valve (and/or turn off the water pump).
- Step 2:** Disconnect power cord of UV system from electrical outlet.
- Step 3:** Release water pressure by opening a downstream faucet and then close the outlet shut-off valve (if any). If there is no outlet shut-off valve, expect water to drain from the system as the head pressure in the system will cause the water to flow back down.
- Step 4:** Remove the captive earth screw from the earth lug on the UV chamber.
- Step 5:** Remove the lamp connector from the chamber (gland nut) by pushing the Lamp connector in and turning it ¼ turn counter-clockwise. Disconnect the lamp connector from the lamp. CAUTION: the lamp may be hot!
- Step 6:** Being careful to touch only the ceramic ends, remove the lamp out of the chamber.
- Step 7:** Unscrew the gland nut from the chamber exposing the end of the quartz sleeve.
- Step 8:** Remove the quartz sleeve and o-ring by **gently twisting and pulling** the quartz sleeve.

Step 9: Using a soft, lint-free cloth or towel wipe the sleeve down using a commercial scale cleaner (i.e. CLR® or similar). This removes scaling or iron deposits that may be on the outside of the quartz sleeve. Be careful not to get any moisture or liquids inside of the sleeve.

Step 10: Dry the sleeve with separate cloth.

Step 11: Replace the o-ring and slide the sleeve back into the chamber following steps 7 and 8 from the installation section of the manual.

Cleaning the UV Sensor

Depending on the water quality, the UV sensor may require periodic cleaning. At a minimum, the UV sensor should be cleaned on an annual basis. The following steps outline a basic cleaning procedure.

Step 1: If a by-pass assembly is installed, shut the inlet valve off to prevent water flow through the system. Otherwise, turn off main water inlet valve (and/or turn off the water pump).

Step 2: Disconnect power cord of UV system from electrical outlet.

Step 3: Release water pressure by opening a downstream faucet and then close the outlet shut-off valve (if any). If there is no outlet shut-off valve, expect water to drain from the system as the head pressure in the system will cause the water to flow back down.

Step 4: Place something under the chamber to catch any water that may come out of the chamber during the removal of the UV sensor.

Step 5: Unscrew (counterclockwise) sensor nut from the chamber and pull the sensor slowly out of the sensor port.

Step 6: Holding the sensor in your hand wipe the flat portion (sensor face) of the sensor with isopropyl alcohol using a clean lint-free cloth.

Step 7: Replace sensor following step 9 from the installation section of the manual.

Operation

Microlene systems come with a feature laden controller that incorporates both the lamp driver (ballast) and control features in one water-tight case. Two main controllers are available for the Microlene systems (depending on your model). Both models feature a power factor corrected, constant current lamp driver with a universal power input.

Please Note: While the LED or display screen is red and the buzzer is sounding the water from the system should NOT be consumed. If any water does pass through the system during this period, please follow the disinfection procedure as outlined in this manual before the water is consumed. For Microlene systems, even though they have a visual and audible warning built into the controller, a green LED or status screen does not necessarily indicate that the water coming from this system is in fact potable (safe to drink). These systems do not measure the level of disinfection; they simply measure the “on-off” status of the lamp. Please have your water checked for microbiological contaminants on a regular basis.



IMPORTANT: Installation of a backflow valve should be in compliance with all local water authority regulations and in accordance with AS/NZS 3500.1.2 and complying with AS/NZS 2845.1.

MCS Controllers



Simplistic in operation, these systems feature a tri-colour LED that indicating system status and a 4-digit display to indicate lamp life remaining. Pressing the button will change the display to indicate total running time. When the UV lamp is on and within its operating age, the LED will be green. When the UV lamp is not on or the lamp life has expired, the LED will be illuminated red and an audible buzzer will sound. To remedy this condition, the UV lamp must be replaced with a new genuine Microlene UV lamp.

MCXS Controllers



A full colour LCD screen provides the user with a detailed description of the system's performance in addition to providing any applicable fault messages and system diagnostics. The controller can be used as both a non-monitored and UV monitored system. If a true UV monitor is required, simply add the optional UV sensor module to the "infinite expandability port" located on the right side of the controller. Simply plug in an optional UV sensor module into the expandability port of a Microlene controller and the system will now monitor the UV intensity of the system!

MCXS Power-up Sequence

On start up, the controller will run through a diagnostic start-up and the sequence will be displayed as follows on the colour LCD:



Next, the controller checks for and initializes any optional modules that may be attached to the system.

UV Sensor
Module Check

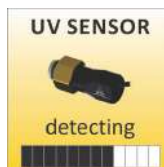

OR



Solenoid
Module Check

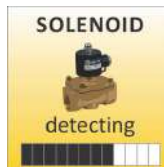

OR



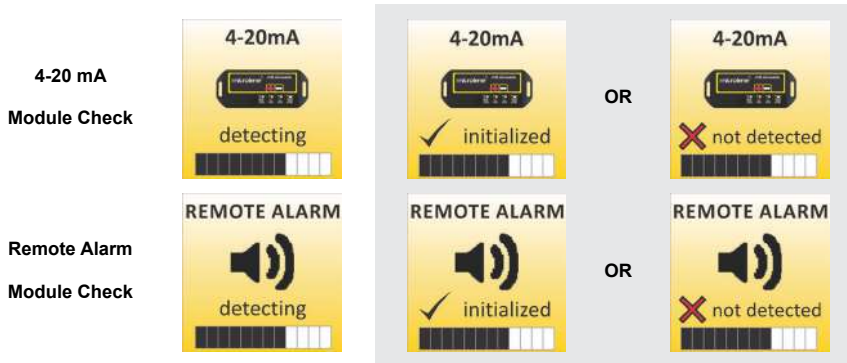

A final module screen is displayed showing which specific modules were initialised. The controller then displays the lamp optimisation screen for 60 seconds to allow the lamp to reach its optimum output. Finally, a final “start-up complete” screen is displayed. The system will now be ready to disinfect water flow.



all detected modules



lamp reaching max output



successful start-up

MCXS Operational Screens

On systems without the UV monitor, the default screen shows the **Microlene Home Screen**. At any point during operation the user is able to scroll through the **Microlene Home Screen, Lamp life remaining, QR Code, Contact Info and Maintenance Parts** screens by pressing the button located on the front of the controller.



On systems with the UV monitor, the system will display the same screens as on the Microlene MCXS controller except the UV Intensity replaces the home screen. The UV Intensity screen displays the level of UV light detected by the sensor. UV intensity can be affected by poor water quality, scaling on the quartz sleeve and/or sensor, lamp failure or lamp expiring. The following screens show the UV Intensity dropping.

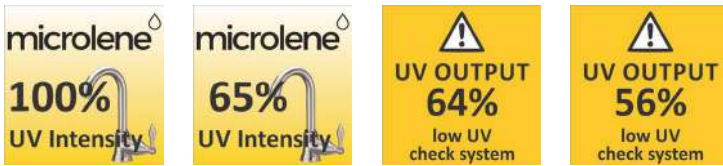

Below 56%, the numbers and warning sign turn red and an audible chirp is given by the ballast every 15 seconds. Below 51%, the screen is solid red and a constant audible alarm is given. This alternates with a screen indicating “water may be unsafe for consumption”. With the solenoid module, the controller de-activates the solenoid valve, shutting off all water flow.

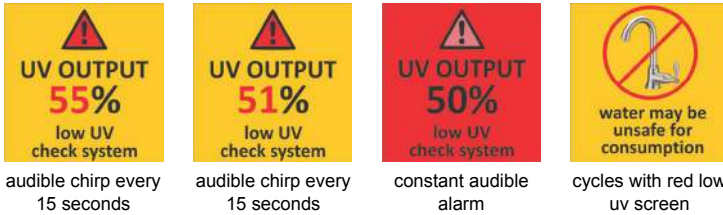

audible chirp every 15 seconds

audible chirp every 15 seconds

constant audible alarm

cycles with red low uv screen

Lamp Countdown Sequence

The system counts down the number of days until a lamp change is required.



At thirty days remaining, the LED or display screen will change to a yellow caution indicator. At seven days remaining, the system will additionally repeat an audible chirp. Past the zero day threshold, the LED or display screen changes to solid red with a continuous alarm sound.



MCS System



At any point during this sequence, the audible chirp or alarm can be deferred for seven days by holding the controller button down for a period of five seconds. The number of deferrals used will be displayed as below. Once the deferral expires, the alarm will sound once again. The deferral can be repeated up to three times.

PLEASE NOTE: At any point after lamp expiration, the water may be unsafe for consumption and should not be consumed without another form of disinfection.

MCXS System



MCS System



System Service Suggested

MCXS controllers will display the System Service Suggested Screen every 6 months to remind consumers to maintain both their UV and other prefiltration. This will serve as a prompt only and will not put the system into alarm. To clear this condition simply press the button located below the screen.



Lamp Replacement (MCS systems)

After the lamp is expired, it must be replaced with the same part number as indicated by the label on the chamber. Begin replacing the lamp by unplugging the power for the controller, then refer to **Installation**, starting with step 11 (page 11) for instructions on installing the new lamp. To reset the timer in the controller, firmly hold down the button on the controller for 10 seconds. The controller will read "rSt3", "rSt2", "rSt1" and then beep. The button can now be released, the lamp countdown timer has been reset. The lamp key that comes with the replacement lamp will not be required on the MCS system and can be discarded.

Lamp Replacement (MCXS systems)

After the lamp is expired, it must be replaced with the same part number as indicated on the Maintenance Parts screen or on the label on the chamber. With the system powered down, remove and discard the lamp key from the controller. The replacement lamp is packaged with a lamp key on the connector at the end of the lamp. Remove the key from the lamp and place it in the controller. Refer to Installation, starting with step 11 (page 11) for instructions on installing the new lamp.







QR Codes

(Only on MCXS controllers MCXS-CONT) A QR code (Quick Response code) is a matrix barcode first designed for the automotive industry. Microlene uses the QR code to store a link to our website. Users with a camera phone equipped with the correct reader application can scan the image of the QR code and over a wireless network connect to our web page in the phone's browser.



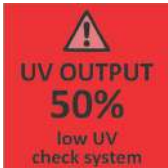



System Troubleshooting

Hard Alarms: The following give a constant audible alarm. If present, the solenoid valve is closed, and the 4-20, remote alarm and WiFi modules transmit the alarm.

System Display	Problem	Resolution
 <p>DANGER lamp failure replace lamp Call Davey at AU 1300 232 839 NZ 0800 654 334</p>	The system has detected a problem with the lamp.	Reset lamp protection circuit – unplug unit for 10 seconds. Replace the lamp with the part as indicated on the silver label on the chamber or on the Maintenance parts screen.
 <p>DANGER lamp expired 1 days ago Call Davey at AU 1300 232 839 NZ 0800 654 334</p>	Although the lamp is powered and visibly illuminated, due to the lamp's age its UV output is no longer sufficient for proper disinfection.	Replace the lamp with the part as indicated on the silver label on the chamber or on the Maintenance parts screen.
 <p>UV OUTPUT 50% low UV check system</p>	Low UV Intensity.	Remove and clean the quartz sleeve and sensor. Check water quality meets requirements on page 5 and add filtration as required. Replace lamp.
 <p>LAMP INCORRECT Required Part: MC-HOLP Installed Part: MCXSL</p>	Wrong lamp or sensor installed.	Replace component with proper model as indicated.
 <p>UV SENSOR FAILURE check connection or see manual</p>	The UV sensor is no longer communicating with the system.	Ensure all modules are connected properly to the system and to each other. Modules can be tested individually by plugging in one at a time and cycling power to the system.
 <p>CONNECTION FAILURE check connection or see manual</p>	A bad connection has been detected in the IEP port.	Replace any module that is not detected when plugged directly into the controller.
 <p>LAMP KEY NOT FOUND check connection or see manual</p> <p>LAMP KEY INVALID check connection or see manual</p>	Missing or incorrect lamp key.	Ensure the lamp key (packed with the lamp, on the connector) is installed. Unplug and reinstall the key. Ensure the key part number matches Lamp on Maintenance Parts screen.

Soft Alarms: The following remaining errors give a 15 second audible chirp only.

System Display	Problem	Resolution
   	<p>The module indicated is no longer communicating with the system.</p>	<p>Ensure all modules are connected properly to the system and to each other. Modules can be tested individually by plugging in one at a time and cycling power to the system. Replace any module that is not detected when plugged directly into the controller.</p>
	<ol style="list-style-type: none"> 1. Turbulent flow is present. 2. Air bubbles or solid particles in the Flowmeter body/pipe. 3. Internal damage caused by plugging an AC/DC wall adapter. that is rated more than +5VDC or dropping the device. 	<ol style="list-style-type: none"> 1. Make sure there is proper length of straight piping on the inlet side of the Flowmeter. As well the direction of flow is in the correct direction. 2. Verify installation is correct, remove any air bubbles from water supply, add filtering to reduce solid particles from entering Flowmeter. 3. Replace Flowmeter.

Warning: After any hard alarm, the home or facility should be disinfected. Follow the steps under the “System Disinfection” heading.



Boil Water Advisory: If any failure occurs on a Microlene UV system, the water must not be used for human consumption until the system is returned to a safe operational mode. If the water is used for human consumption during this period, the water must be boiled (minimum 20 minutes at a full boil) prior to consumption.

Temperature Management Devices

Your Microlene system is designed to run continuously to ensure optimal disinfection. However, during periods when no water is drawn through the system, the energy from the disinfection process can cause the temperature of the water inside the chamber to rise. In extreme situations elevated water temperature or the fluctuation in temperature can lower the output of the UV lamp. In these cases, or if the elevated water temperature is a nuisance, Microlene recommends the following form of temperature management device.



Temperature Relief Valve (TRV)

On reaching a higher temperature, the TRV is designed to drain a small amount of water to allow fresh, cooler water to enter the system. The TRV works without power and comes complete with 10' of drain line. The TRV should be used in standard installs where the ambient temperature regularly exceeds 35 degrees C ambient temperature. Order PN **DM130033** for 1” ports.

Expansion Modules

Microlene MCXS controllers incorporate an “Infinite Expandability Port” (IEP) which allows for expansion to the UV sensor and all other modules. Each module (including the sensor) comes with both a male and female connection. Connect any device to the controller and all subsequent devices are then connected into the female end of last device added in a “daisy chain” configuration.



The following optional expansion modules are available for use on Microlene UV controllers. Contact your authorised distributor for purchasing information.



REMOTE ALARM CONNECTION MODULE: Allows for a connection to a remote device such as a buzzer, light, alarm system, PLC, etc., via a pair of contacts. In normal operation the OK and COM contacts will be connected, and in a fault condition (Low UV, Lamp fail, Power Fail), the Fault and COM contacts will be connected. Maximum Contact Rating is 30V / 1A (use 16-22 AWG). Order PN **DMMOD-RAM**.

SOLENOID CONNECTION MODULE: Connects a NORMALLY CLOSED line voltage solenoid valve to the controller. On a non-monitored system, the solenoid will only close on a lamp failure error. On a monitored system, the solenoid is closed when the UV level drops below 50%. Also note that in cases where emergency use of untreated water is required, the controller can be placed into a manual override mode allowing for the flow of water in an alarm condition. Maximum contact rating is 240VAC (50-60Hz) / 30VDC / 2A. Order PN **DMMOD-SOL1**.

4-20 mA MODULE: Outputs a 4-20mA signal of the UV output to a remote device such as a data logger or computer. Order PN **DMMOD-420**.

Expansion Modules

	Microlene EQUIPMENT SPECIFICATIONS	
	RACK-MOUNT UV SYSTEMS	
MODEL	MCS	MCSX
Flow Rate (@16mJ/cm ²)	30.1 USgpm	
	114 lpm	
	6.84 m ³ /hr	
Flow Rate (@30mJ/cm ²)	15.0 USgpm	
	56.8 lpm	
	3.4 m ³ /hr	
Flow Rate (@40mJ/cm ²)	12.0 USgpm	
	45.4 lpm	
	2.7 m ³ /hr	
Filter Housing - 1	20 micron sediment 20PP20J	
Filter Housing - 2	1 micron sediment 1PS20J	
Port Size	1" FNPT (filter side) / 1" MNPT (UV side)	
Electrical	90-265V/50-60Hz	
Plug Type	Australian/New Zealand: AS/NZ 3112	
Lamp Power (Watts)	45 (high-output lamp)	
Power (Watts)	57 (48 @ 230V)	
Replacement Lamp	MC-HOLP	
Replacement Sleeve	MC-HOSL	
Chamber Dimensions	8.9 x 50.8 cm (3.5 x 20")	
Chamber Material	Polished 316L Stainless Steel, A249 Pressure Rated Tubing	
Controller Dimensions	21.8 x 10.7 x 8.9 cm (8.6 x 4.2 x 3.5")	
Operating Pressure	827kPa (120PSI)	
Operating Water Temperature	2-40° C (36-104° F)	
UV Monitor	not available	OPTIONAL (optional UV module sold separately)
Solenoid Output	YES (optional solenoid module sold separately)	
Dry Contacts	not available	YES (remote alarm module sold separately)
4-20mA Output	not available	YES (remote alarm module sold separately)
Lamp Change Reminder (audible & visual)	YES	
Lamp Out Indicator (audible & visual)	YES	

Davey Warranty

Products manufactured by Davey Water Products Pty. Ltd. are warranted to the original user only to be free of defects in material and workmanship for a period as specified below. This warranty only applies to the original purchaser and is not transferable.

UV Systems

Ten (10) year Limited Warranty on the stainless steel chambers, from the date of original purchase, or installation (proper documentation required for verification).

Electronics

Three (3) year Limited Warranty on the ballasts and controllers, from the date of original purchase, or installation (proper documentation required for verification).

UV Lamps, UV Sensors & Quartz Sleeves

One (1) year Limited Warranty on all US WATER ultraviolet lamps, UV sensors and quartz sleeves from the date of original purchase, or installation (proper documentation required for verification).

This warranty does not cover normal wear and tear or apply to a product that has:

- been subject to misuse, neglect, negligence, damage or accident
- been used, operated or maintained other than in accordance with Davey's instructions
- not been installed in accordance with the Installation Instructions or by suitably qualified personnel
- been modified or altered from original specifications or in any way not approved by Davey
- had repairs attempted or made by other than Davey or its authorised dealers
- been subject to abnormal conditions such as incorrect voltage supply, lightning or high voltage spikes, or damages from electrolytic action, cavitation, sand, corrosive, saline or abrasive liquids,

The Davey warranty does not cover replacement of any product consumables or defects in products and components that have been supplied to Davey by third parties (however Davey will provide reasonable assistance to obtain the benefit of any third-party warranty).

To make a warranty claim:

- If the product is suspected of being defective, stop using it and contact the original place of purchase. Alternatively, phone Davey Customer Service or send a letter to Davey as per the contact details below
- Provide evidence or proof of date of original purchase
- If requested, return the product and/or provide further information with respect to the claim. Returning the product to the place of purchase is at your cost and is your responsibility.
- The warranty claim will be assessed by Davey on the basis of their product knowledge and reasonable judgement and will be accepted if:
 - a relevant defect is found
 - the warranty claim is made during the relevant warranty period; and
 - none of the excluded conditions listed above apply
- The customer will be notified of the warranty decision in writing and if found to be invalid the customer must organise collection of the product at their expense or authorise its disposal.

If the claim is found to be valid Davey will, at its option, repair or replace the product free of charge.

The Davey warranty is in addition to rights provided by local consumer law. You are entitled to a replacement or refund for a major failure and compensation for any other reasonably foreseeable loss or damage. You are also entitled to have the goods repaired or replaced if the goods fail to be of acceptable quality and the failure does not amount to a major failure.

For any internet connected products the consumer is responsible for ensuring a stable internet connection. In the event of a network failure the consumer will need to address the concern with the service provider. Use of an App is not a substitute for the User's own vigilance in ensuring the product is working to expectation. Use of a Smart Product App is at the User's own risk. To the fullest extent permitted by law Davey disclaims any warranties regarding the accuracy, completeness or reliability of App data. Davey is not responsible for any direct or indirect loss, damage or costs to the User arising from its reliance on internet connectivity. The User indemnifies Davey against any claims or legal actions from them or others relying on internet connectivity or App data may bring in this regard.

Products presented for repair may be replaced by refurbished products of the same type rather than being repaired. Refurbished parts may be used to repair the products. The repair of your products may result in the loss of any user-generated data. Please ensure that you have made a copy of any data saved on your products.

To the fullest extent permitted by law or statute, Davey shall not be liable for any loss of profits or any consequential, indirect or special loss, damage or injury of any kind whatsoever arising directly or indirectly from Davey products. This limitation does not apply to any liability of Davey for failure to comply with a consumer guarantee applicable to your Davey product under local laws and does not affect any rights or remedies that may be available to you under local laws.

For a complete list of Davey Dealers visit our website (daveywater.com) or call:

DAVEY

Davey Water Products Pty Ltd
Member of the GUD Group
ABN 18 066 327 517

daveywater.com

AUSTRALIA

Customer Service Centre

6 Lakeview Drive,
Scoresby, Australia 3179
Ph: 1300 232 839
Fax: 1300 369 119
Email: sales@davey.com.au

NEW ZEALAND

Customer Service Centre

7 Rockridge Avenue,
Penrose, Auckland 1061
Ph: 0800 654 333
Fax: 0800 654 334
Email: sales@dwp.co.nz

© Davey is a registered trademark of Davey Water Products Pty Ltd. © Davey Water Products Pty Ltd 2021.

DWP1390-1

* Installation and operating instructions are included with the product when purchased new. They may also be found on our website.

DAVEY

DAVEY DynaDrive™

Constant Pressure System

Installation and Operating Instructions

Models:	DD60-10(CE)	CE	DD60-10NPT	
	DD90-11(CE)		DD90-11NPT	



ATTENTION: Please refer to www.bit.ly/dynadrive for any product information updates, or simply scan this QR code. These can also be found on the product nameplate.



**Please pass these instructions on to the operator of this equipment.
READ AND SAVE THESE INSTRUCTIONS.**

DAVEY DynaDrive™

Congratulations on your purchase of a high quality, Davey DynaDrive constant pressure system. All components have been designed and manufactured to give trouble free, reliable operation.

Contents

1. PRIOR TO USING THIS PRESSURE SYSTEM, YOU MUST ENSURE THAT	3
2. YOUR NEW SYSTEM	4
3. APPLICATIONS	4
3.1 Above ground water sources (flooded suction)	4
3.2 In-ground water sources (eg suction lift from in ground tank)	4
3.3 Spear point installations	4
3.4 Connecting mains scheme or town water supply to either suction, or discharge of pumps and pressure systems	5
3.5 Installs with a mains pressure hot water system	5
4. INSTALLATION	5
4.1 Choosing a site	5
4.2 Pipe connections	5
4.3 DynaDrive with air handling capacity	6
4.4 Power connection	6
4.5 The pressure tank	7
5. FEATURES	8
5.1 System features	8
5.2 DynaDrive display layout	8
5.3 VSD features	9
6. OPERATION	9
6.1 Start-up procedure	9
6.2 Manual override	11
6.3 Main menu display	13
6.4 Changing the set pressure	14
6.5 Extra draw-off capacity	16
6.6 Decommissioning the DynaDrive	16
7. ADVANCED SETTINGS	17
7.1 Changing cut-in pressure point	17
7.2 Changing the min frequency	18
7.3 Using a switch to override DynaDrive operation	20
7.4 Daisy-chain multiple DynaDrive systems	23
8. TECHNICAL SPECIFICATIONS	24
8.1 Operating limits	24
8.2 Hydraulic performance	24
8.3 Dimensions	26
8.4 Electrical data	26
8.5 Materials of construction	26
10. MAINTENANCE	27
10.1 Periodic pressure tank checks	27
11. TROUBLESHOOTING	28
12. SPARE PARTS	28
13. DAVEY WARRANTY	30
13.1 Warranty inside the USA	30
13.2 Warranty outside the USA	32



CAUTION: This pump has been evaluated for use with water only. Do not insert any object in the opening. Before using this pump, the pump must be well installed. Children should be supervised that they do not play with the pump. NPT model variants acceptable for indoor use only, do not used outdoor. For use with maximum 80°C (176°F) water.



WARNING: Risk of electric shock. This pump is supplied with a grounding conductor and grounding-type attachment plug. To reduce the risk of electric shock, be certain that it is connected only to a properly grounded, grounding-type receptacle. Non-submersible pump. This pump has not been investigated for use in swimming pool or marine areas. To reduce risk of electric shock, pull plug before servicing or cleaning this pump. Do not operate this pump with wet hands.



ATTENTION: The DynaDrive system and associated pipework operate under pressure. Under no circumstances should the DynaDrive system, or associated pipework be disassembled unless the internal pressure of the system has been relieved. Failure to observe this warning will expose persons to the possibility of personal injury and may also result in damage to the pump, pipework or other property.

This appliance is not intended for use by persons (including children) with reduced physical, sensory or mental capabilities, or lack of experience and knowledge, unless they have been given supervision or instruction concerning use of the appliance by a person responsible for their safety. Children should be supervised to ensure that they do not play with the appliance. This appliance can be used by children from aged 8 years and above and persons with reduced physical sensory, mental capabilities, or lack of experience and knowledge if they have been given supervision, or instruction concerning use of the appliance in a safe way and understand the hazards involved. Maximum pressure limited to 64m (210 feet) total head.



IMPORTANT: If the supply cord is damaged, it must be replaced by the manufacturer, its service agent, or similarly qualified persons in order to avoid a hazard. Cleaning and user maintenance shall not be made by children without supervision. Children shall not play with the appliance.

Outside the United States, pump is to be supplied through a residual current device (RCD) having a rated residual operating current not exceeding 30mA.

In the United States, the National Electrical Code requires GFCI devices intended to protect people to interrupt the circuit if the leakage current exceeds a range of 4-6mA of current (the trip setting is typically 5mA) within 25ms. GFCI devices which protect equipment (not people) are allowed to trip as high as 30mA of current.

Prior to installation remove the inlet and outlet pipe transport plugs & associated seals from the suction and/or discharge ports.

1. PRIOR TO USING THIS PRESSURE SYSTEM, YOU MUST ENSURE THAT

- The pump is installed in a safe and dry environment
- The pump enclosure has adequate drainage in the event of leakage
- Any transport plugs are removed
- The pipework is correctly sealed and supported
- The pump is primed correctly
- The power supply is correctly connected
- All steps have been taken for safe operation

Appropriate details for all these items are contained in the following Installation and Operating Instructions. Read these in their entirety before switching on this pump. If you are uncertain as to any of these Installation and Operating Instructions, please contact your Davey dealer, or the appropriate Davey office as listed on the back of this document.

2. YOUR NEW SYSTEM

1. Suction inlet
2. Pump body
3. Pump priming plug
4. Discharge/delivery outlet
5. DynaDrive control module
6. Motor
7. Pressure tank (optional extra for CE model variants)

DD60-10(CE/NPT)
DD90-11(CE/NPT)
Figure 2.1

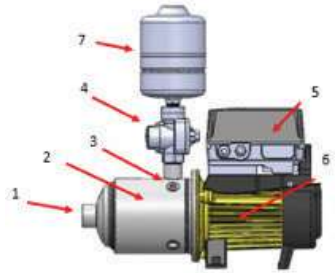

3. APPLICATIONS

3.1 Above ground water sources (flooded suction)

Installations with flooded suction require a gate valve so water supply can be turned off for pump removal and servicing, see figure 3.1. There is no need to install a one-way check valve in the suction pipeline as there is a one-way check valve installed in the tee piece immediately on top of the DynaDrive pump discharge.

3.2 In-ground water sources (eg suction lift from in ground tank)

Whenever the installation position of the pump is higher than the lowest water level, a foot valve should be fitted to the end of the suction pipe, see figure 3.2. Ensure that the foot valve is at least ½ metre (1½ feet) below minimum water level to avoid a vortex of air being drawn into pipe.

In suction lift installations that have an unreliable foot-valve it may be preferable to remove the check valve in the DynaDrive discharge tee piece. Doing so will allow the DynaDrive pressure transducer to “recognise” a loss of water from a suction line, while the DynaDrive is in standby. Applications of this nature, with long &/or wide suction lines consist of a considerable volume of water, ie > 100 litres (26 US gallons) in the suction pipe. Temperature variations of the water may create fluctuations in the pressure of the water, falsely triggering the DynaDrive to start/stop. In such as case, it is worth considering upsizing the pressure tank to help absorb these pressure fluctuations. If concerned, please consult your Davey representative.

3.3 Spear point installations

When a pump is installed on a spear, or well point, a check valve fitted immediately on top of the spear point itself, see figure 3.3. Do not install the check valve at the pump, or at the top of the well. Do not run the pump without water in it.

In suction lift installations that have an unreliable foot-valve it may be preferable to remove the check valve in the DynaDrive discharge tee piece. Doing so will allow the DynaDrive pressure transducer to “recognise” a loss of water from a suction line, while the DynaDrive is in standby. Applications of this nature, with long &/or wide suction lines consist of a considerable volume of water, ie > 100 litres (26 US gallons) in the suction pipe. Temperature variations of the water may create fluctuations in the pressure of the water, falsely triggering the DynaDrive to start/stop. In such as case, it is worth considering upsizing the pressure tank to help absorb these pressure fluctuations. If concerned, please consult your Davey representative.

Figure 3.1

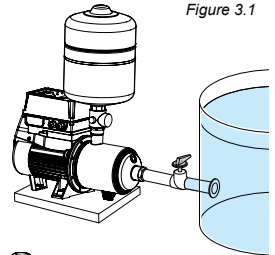

Figure 3.2

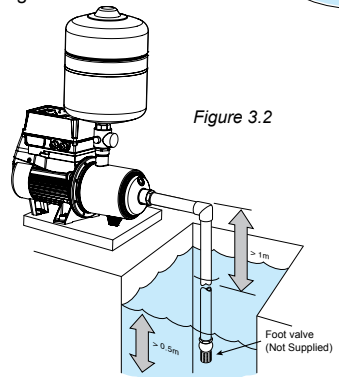
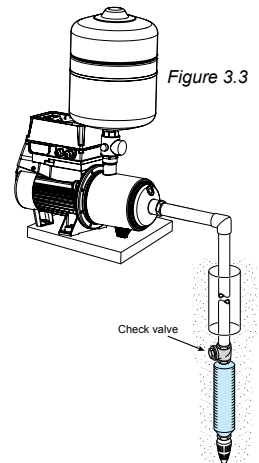
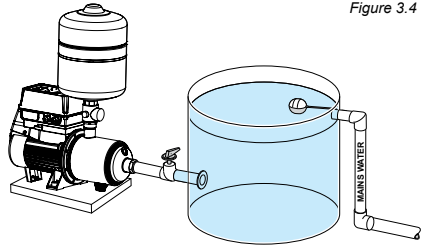

Figure 3.3



3.4 Connecting mains scheme or town water supply to either suction, or discharge of pumps and pressure systems

Most Water Supply Authorities have strict regulations regarding direct connection of pumps to mains water supplies. In most cases an isolating tank is required between mains supply and pump, see figure 3.4. Davey also recommend this method. Directly applied mains pressure can exceed pump operating pressure and damage pump. Davey Water Products Pty Ltd cannot accept responsibility for loss, or damage resulting from incorrect, or unauthorised installations.



3.5 Installs with a mains pressure hot water system



ATTENTION: Always ensure hot water systems are installed in compliance with manufacturers recommendations and in accordance with all local regulations.

To protect your system from damage caused by back pressure from hot water systems, see figure 3.5. You should always have installed on the hot water inlet an approved non-return valve.

Davey Water Products Pty Ltd cannot accept responsibility for loss or damage resulting from incorrect, or unauthorised installations.

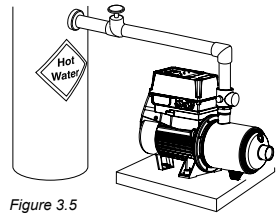

Figure 3.5

4. INSTALLATION

4.1 Choosing a site

Choose a clean and dry site with a firm base as close to the water source as possible with correct power supply. Make sure your pump is always connected to an adequate, reliable source of clean water. To protect your pump from the weather, make sure the pump house is both waterproof, frost free and has adequate ventilation. The pump should be mounted on a firm base allowing for drainage, to avoid damage to flooring etc., that over time may occur from leaking pipe joints or pump seals. Do not mount the pump vertically. Never place flammable materials on, or near your pump.

The pressure that DynaDrive comes pre-set to is as follows:

- * DD60-10(CE) 400kPa (58psi);
- * DD90-11(CE) 400kPa (58psi);
- * DD60-10NPT 414kPa (60psi); or
- * DD90-11NPT 414kPa (60psi).

However, it is possible to adjust the pressure set point. Some plumbing authorities impose a pressure limitation on the pressure of water into a dwelling. Consideration of operating pressures should also be given to appliances within the dwelling. If unsure, check with local authorities, or a licenced contractor.

4.2 Pipe connections



IMPORTANT: Suction leaks are the largest cause of poor pump performance and are difficult to detect. Ensure all connections are completely sealed using thread tape only. DO NOT USE SEALING COMPOUNDS, HEMP, OR PIPE DOPE.

For best performance use P.V.C, or polythene pipe with a diameter at least the same as the pump's inlet. Larger diameter pipe may be used to minimise resistance to flow when pumping for distances longer than 5m (16'). Use unions at pipe connections to enable easy removal and servicing.

Use enough "plumbers' tape" to ensure airtight seal and hand tighten only, do not screw connections all the way into suction port, see figure 4.1. To prevent strain on pump thread always support heavy inlet and outlet pipes.

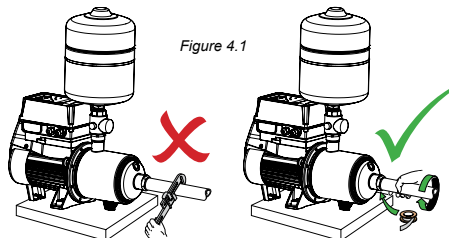

Figure 4.1

Lay suction pipe at a constant gradient to avoid air pockets which may reduce pump efficiency, see figure 4.2.

Avoid installing 90° elbows before the suction inlet of the pump, within a distance equivalent to 5 x pipe diameter. For example: using 40mm (1½") suction pipe, avoid installing a 90° elbow within 200mm (7¾") of the pump inlet. This will assist laminar flow.

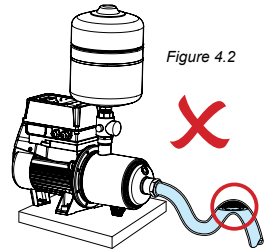

Figure 4.2

4.3 DynaDrive with air handling capacity

Your DynaDrive has the benefit of a new upgraded self-priming and air handling capability. While Davey must stress the overall requirement for all suction lines to be airtight, we also are aware that sometimes removing air from suction lines or stopping minor leaks can be difficult. For this reason, Davey have incorporated special features into your new pump or pressure system to make operation easier and more dependable.

To help you get the most from this new capability please read this addendum in conjunction with the full Installation and Operating Manual included with your pump.

Plumbing: Pay special attention to ensuring the suction pipe and associated fittings are airtight. The absence of a water leak on the suction line may not confirm that the pipe or fittings are airtight.

Should the suction line contain air pockets it can aid the priming process greatly if you can temporarily isolate the discharge line from the pump and instead use an adjacent tap to allow the pump to discharge water until full prime is established. Such a facility is also useful for future servicing and troubleshooting should it be required.

Priming: Filling the pump and suction line with water is made much easier by filling from the outlet side and allowing any trapped air in the pump to evacuate via one of the plugged holes on the pump casing.

- Remove the tee piece on the top of the pump when trying to fill as this contains a check (one-way) valve, that won't otherwise allow water to enter the pump casing;
- Remove priming plug and fill casing and suction line (on flooded suction, simply open gate valve to pump). When full, replace priming plug;
- Ensure outlet nearest to pump is open;
- Ensure all valves in suction line are open;
- Switch on power. All LEDs on the display will flash;
- Refer section "6.1 Start Up Procedure". A full flow of water should be discharged from the open tap.

4.4 Power connection



IMPORTANT: Long extension leads should be avoided as they often have insufficient current carrying capacity to run electric motors, hence they can cause substantial voltage drop and operating problems.

If the electrical fittings in your country make it necessary to remove the plug from the lead fixed to the motor care should be taken to ensure that the earth conductor green/yellow in the lead is properly connected to a good earth. CAUTION: For models DD60-10NPT and DD90-11NPT, compliance dictates removal of the power cord and plug is not allowable.



ATTENTION: Ensure that any and all electrical work is only undertaken by an authorized electrician. Before obtaining access to terminals, all supply circuits must be disconnected.

The electrical connections and checks must be made by a qualified electrician and comply with applicable local standards. Poor installation, or poor power supply may even result in electrical fires!



ATTENTION: Automatic reset thermal overloads will allow the pump to restart without warning. ALWAYS disconnect the pump motor from the electrical supply before maintenance or repairs.

NOTE:

- Ensure motor is connected to power supply specified on nameplate;
- Although the Davey electric motor is specifically engineered to perform on a range of power supply voltages, malfunctions or failure caused by adverse voltage supply conditions are not covered under guarantee.



ATTENTION: We are obliged to inform you that this pump is not to be used by children, or infirm persons and must not be used as a toy by children. Some insects such as small ants, find electrical devices attractive for various reasons. If your pump enclosure is susceptible to insect infestation you should implement a suitable pest control plan.

4.5 The pressure tank



IMPORTANT: Air pressure in pressure tank should be set to 70% of the DynaDrive set pressure. For example, the pressure that DynaDrive comes pre-set to is as follows:

DD60-10(CE) 400kPa (58psi);
DD90-11(CE) 400kPa (58psi);
DD60-10NPT 414kPa (60psi); or
DD90-11NPT 414kPa (60psi).

The default air pressure of the pressure tank used with DynaDrive should be set to:

DD60-10 280kPa (41psi);
DD90-11 280kPa (41psi);
DD60-10CE 280kPa (41psi) tank purchased separately;
DD90-11CE 280kPa (41psi) tank purchased separately;
DD60-10NPT 290kPa (42psi); or
DD90-11NPT 290kPa (42psi)

Never over-charge the tank. Always use air at ambient temperature. Do not overtighten. During air replenishment the tank should be externally inspected. Any signs of leakage from the tank may indicate a need for immediate replacement.

If air charge adjustment is required, then follow these procedures:

- Remove the pressure tank completely from pump installation, ensuring to isolate the pressure tank and release the water pressure from the tank beforehand; or
- Release all water pressure from the pressure tank by switching off the pump at the power point and opening the closet tap. For above ground supply tanks, it is necessary to close the gate valve between the supply tank and the pump;



ATTENTION: To prevent personal injury, ensure all water pressure is released from the pressure system prior to work being performed.

- Leave tap open during air replenishment;
- When all water pressure has been released from the system, check air pressure at air valve on top of pressure tank. The pre-charge pressure reading should be 70% of set point pressure;
- If necessary, replenish air charge to the correct pressure indicated. Ensure that a tap in outlet piping of pump is open during replenishment of air pre-charge.

5. FEATURES

5.1 System features

- Provides warning indications for system faults;
 - Has adjustable pressure setting to allow for various operating conditions;
 - Provides automatic “cut-out” protection should the pump run out of water, should the pump fail to start due to low voltage or a blockage in the pump;
 - Enables the pump to deliver a constant pressure of water particularly across a wide range of flow rates – reducing the inconvenience of pressure variation in showers etc.
- * Allows for independent switch to override DynaDrive operation. This could be particularly handy if using a float switch in a source tank;
- * Allows for remote alarm monitoring;
- * Allows for daisy-chain multiple DynaDrive systems; and
- * Allows for adjustment of cut-in pressure. This could be particularly handy in applications with slow leaks.

5.2 DynaDrive display layout

Figure 5.1

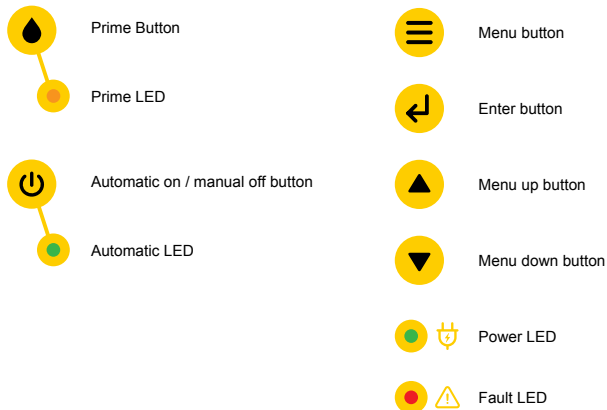
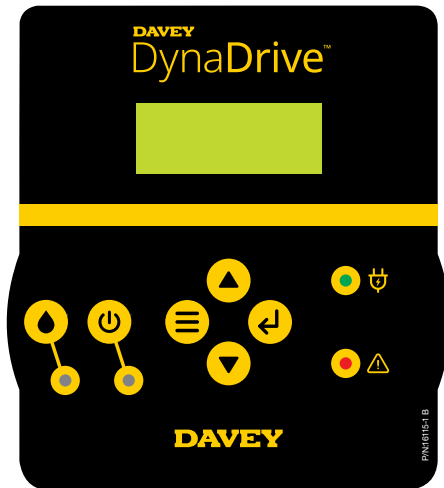

- Using the ▲ **Menu up button** or ▼ **Menu down button** we can change the values on display.
- Press ↵ **Enter button**, for validation.
- Whenever you want to quit the configuration sequence, press ☰ **Menu button**.
- After every ↵ **Enter button**, DynaDrive will switch to the next menu in the configuration sequence.

5.3 VSD features

- Auto reset after dry run detected;
- Auto reset after loss of power;
- Option for adapting (volt-free) tank level sensor into programming;
- Control and information panel with LCD screen;
- Includes pressure transducer;
- Under current visual alarm;
- Over current protection by way of shut down and visual alarm;
- Data logging of operation controls and alarms including run duration;
- Aluminum heat exchanger;
- VSD cooling by pump's fan, lowering cooling costs by way of additional fans;
- Motor and VSD protection from onsite "brown-outs" by way of shut down, visual alarm & auto re-try after correct voltage regained;
- Protection from motor locked rotor by way of auto shut down;
- Adaptable for daisy-chain multiple pumps in parallel, up to 2 pumps;
- Fault diagnosing software for user troubleshooting;
- Adjustable pressure set points via easy to use touchpad in 10kPa (1½psi) increments;; and
- 3-minute manual override for priming.

6. OPERATION

6.1 Start-up procedure

After power is initially turned on to the DynaDrive, the display shows the software version and the name Davey, see figure 6.1. All LEDs flash for the initial ~ 5 seconds. The 🔌 **Power LED** will remain lit green, showing the DynaDrive has power.



Figure 6.1

The display then reverts to the **HOME SCREEN**, see figure 6.2. The  **Power LED** will show bright green. The display shows the pre-set pressure on the top line, shown in Figure 6.2, and pressure being measured by the DynaDrive pressure transducer on the bottom line, shown in Figure 6.2.

The default unit of measurement is as follows:

- * DD60-10(CE): kPa;
- * DD90-11(CE): kPa;
- * DD60-10NPT: psi; and
- * DD90-11NPT: psi.



Figure 6.2

To start the DynaDrive:



- Pushing the  **Automatic on / manual off button** toggles between **automated control** and **manual off**;
- Pushing the  **Automatic on / manual off button** will turn on the pump and it will continue to pump water until set pressure is achieved, see figure 6.3;



Figure 6.3

- The  **Automatic LED** will illuminate bright green indicating that the pump is running

Once the set pressure has been achieved, the DynaDrive will slow the motor speed. If the pressure drops below set pressure, the motor speed will increase again to maintain pressure. However, if the pressure does not drop below set pressure, the motor speed will continue to decrease, until it's off.



- The  **Automatic LED** will flash green to indicate the pump is in standby maintaining pressure, see figure 6.4.



Figure 6.4

6.2 Manual override

In addition to automated control, DynaDrive can also be run in manual override on, should the need arise.



IMPORTANT: It should be noted that when the pump is manually turned on, the automated protection built into DynaDrive is overridden. Davey recommends use of the manual override only when absolutely necessary and only for a short time period.

To switch to manual override on:

- Ensure **automated control** is turned off. To turn the automated control off, push the  **Automatic on / manual off button**.



- The green  **Automatic LED** will turn off, see figure 6.5;



Figure 6.5

- Press and hold the  **Prime button**. The pump will turn on and continue to run until the  **Prime button** is released, see figure 6.6;

While the pump is in manual override the  **Prime LED** will illuminate orange, see figure 6.6.

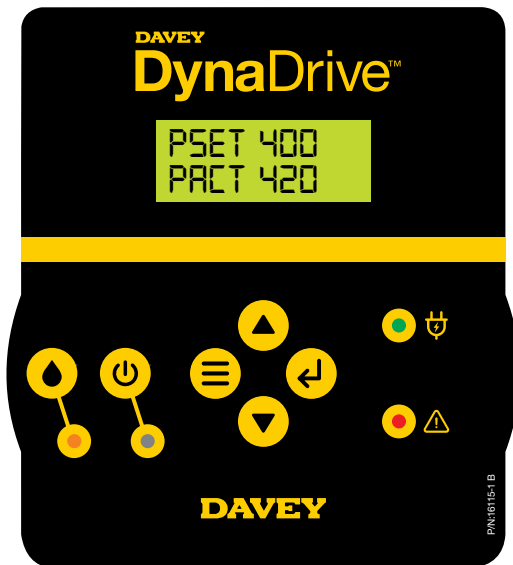

Figure 6.6

6.3 Main menu display

After initial startup, pressing the  **Menu up button** will allow display to scroll through the following:

- Frequency (Hz);
- Outgoing current per phase from the DynaDrive to the pump's motor (Amps);
- Temperature of the DynaDrive ($^{\circ}\text{C}$).

To change the display:

- Press the  **Menu up button**;
- The display will continue to show the pressure set, but changes from showing actual pressure, to the frequency of power supplying the motor, see figure 6.7. This dictates the speed that the motor runs;



Figure 6.7



- Pressing the  **Menu up button** again will display the motor current draw per phase, and the temperature of the DynaDrive controller, see figure 6.8;



Figure 6.8

- To change the display back to normal, scroll back through the menu by pressing the  **Menu down button** twice.

6.4 Changing the set pressure



IMPORTANT: WHEN ADJUSTING SET PRESSURE, DO NOT EXCEED THE PRESSURE CAPABLE OF THE DYNADrive IN THE GIVEN INSTALLATION. REFERENCE TO AS/NZS 3500/2003 (OR LOCAL EQUIVALENT) SHOULD ALSO BE CONSIDERED. When changing the set pressure of DynaDrive, the pressure of the pressure tank must also be adjusted. Refer to section 4.5 pressure tank, of the installation chapter.

The set pressure cannot be changed while the pump is running, or in automatic mode.
To change the set pressure:

- Ensure **automated control** is turned off. To turn the automated control off, push the  **Automatic on / manual off button**.

- The green  **Automatic LED** will turn off, see figure 6.5;

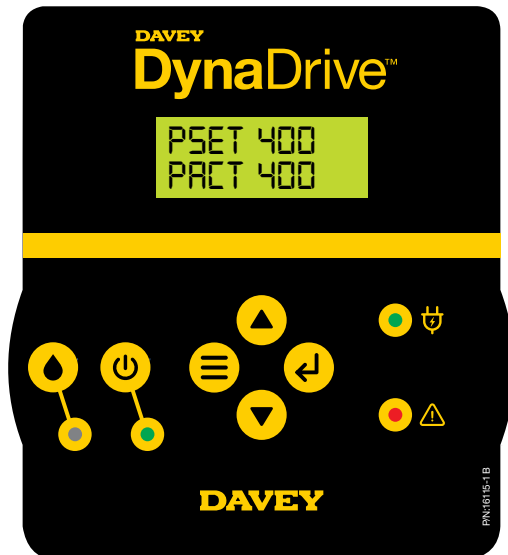



Figure 6.9

- Once the motor has slowed to a stop, press and hold the  **Menu button** for ~ 5 seconds. The display will change to show your current set pressure, see figure 6.10;

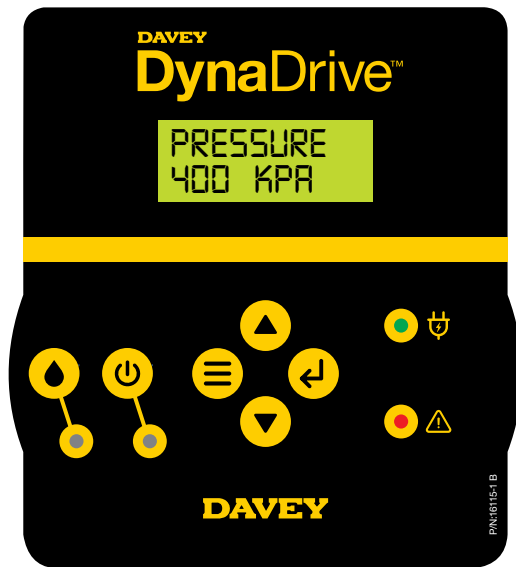

Figure 6.10

- If the controls are untouched for ~ 30 seconds, the menu will revert back to normal display;
- To change the set pressure, use the ▲ **Menu up button** or ▼ **Menu down button**. Pressure changes are in multiples of 10kPa for DD60-10(CE) and DD90-11(CE) models, and 5psi for NPT model variants.
- Once you've reached your new set point, see figure 6.11;



Figure 6.11

- Press ◀ **Enter button**, or ≡ **Menu button** to return to the **HOME SCREEN**, see figure 6.12;



Figure 6.12

- Now restart automatic operation by pressing  **Automatic on / manual off** button.

6.5 Extra draw-off capacity

The DynaDrive has a pressure tank included as part of the system which will accommodate small leaks. In some applications it may be appropriate to install an additional (or larger) accumulator (pressure tank) capacity. These applications include:

- Long suction lines;
- Low flow appliances connected to the pump, such as evaporative air conditioners, slow filling toilet cisterns, where flows can be a little as 0.5L/min (0.13gpm).

Any additional accumulators can be installed downstream of the controller (ie. between the controller and the first outlet). Where extra draw-off capacity is utilised the additional pressure tank should have a pre-charge 70% of the system set pressure. For installations requiring flow rates between 125-500mL/min (33 – 132gpm), it is common for the DynaDrive to run continuously. If this occurs, adjust up the min frequency setting (refer section 7.4) and install a larger pressure tank. If you have any further concerns, please contact your local Davey representative.

6.6 Decommissioning the DynaDrive

Should it become necessary to decommission the DynaDrive to relocate the it, store it, or conduct some service maintenance for example:

- Turn off the power to the DynaDrive and unplug it from electrical supply;
- Close any isolation valves on the suction side of the pump;
- Open a tap, or outlet on the delivery side of the pump and discharge excess pressure in the line;
- Close any isolation valves on the delivery side of the pump;



ATTENTION: It is essential that the system is de-pressurized before proceeding. Failure to do so could result in harm to product &/or user.

- Unscrew the pressure tank from the top of the DynaDrive discharge/delivery outlet. **NOTE:** depending on the installation it is possible that water may spill from the pipework and pressure tank. It would be good practice to prepare for this;
- Unscrew pipework from the DynaDrive discharge/delivery outlet;
- Unscrew pipework from the DynaDrive suction inlet;
- Slide DynaDrive out of location.

7. ADVANCED SETTINGS

7.1 Changing cut-in pressure point

The default cut-in pressure of DynaDrive is 50kPa (7psi) less than set point. This can be changed by:





- Ensure **automated control** is turned off. To turn the automated control off, push the  **Automatic on / manual off button**.
- The green  **Automatic LED** will turn off, see figure 7.1;



Figure 7.1

- Once the motor has slowed to a stop, press and hold the  **Menu button** and  **Enter button** for ~ 5 seconds. The display will change to show your current set pressure, see figure 7.2;

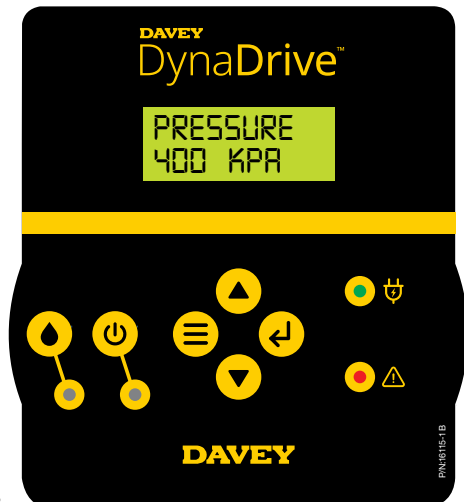

Figure 7.2

- If the controls are untouched for ~ 30 seconds, the menu will revert back to normal display;
- Using the ▲ **Menu up button** and ▼ **Menu down button** scroll through to Cut-in;
- Use the ▲ **Menu up button** and ▼ **Menu down button** to change the setting to adjust the cut-in pressure variance;
- Press the ↵ **Enter button** to save settings and return to the **HOME SCREEN**;
- Now restart automatic operation by pressing ⏻ **Automatic on / manual off button**.

In a daisy-chain installation, the cut-in of the secondary pump occurs after the same pressure drop as the primary pump is set.

7.2 Changing the min frequency

The default minimum frequency of DynaDrive is 15Hz. This can be changed by:

- Ensure **automated control** is turned off. To turn the automated control off, push the ⏻ **Automatic on / manual off button**.

- The green ⏻ **Automatic LED** will turn off, see figure 7.3;



Figure 7.3

- Once the motor has slowed to a stop, press and hold the ≡ **Menu button** and ↵ **Enter button** for ~ 5 seconds. The display will change to show your current set pressure, see figure 7.4;

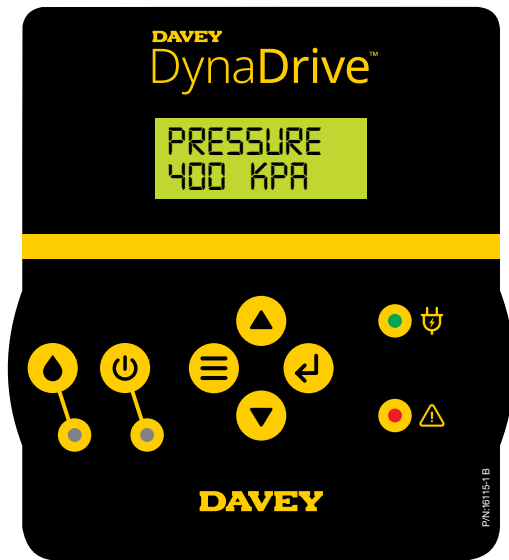







Figure 7.4

- If the controls are untouched for ~ 30 seconds, the menu will revert back to normal display;
- Using the  **Menu up button** and  **Menu down button** scroll through to Min Freq.
- Use the  **Menu up button** and  **Menu down button** to change the setting to. The setting will change by 5Hz;
- Press the  **Enter button** to save settings and return to the HOME SCREEN;
- Now restart automatic operation by pressing  **Automatic on / manual off button**.

7.3 Using a switch to override DynaDrive operation

DynaDrive has the ability to be overridden by a separate switch. This may be of benefit if using a float switch on a source tank (eg rainwater tank). To wire in an independent switch, refer figure 7.5 and 7.6.

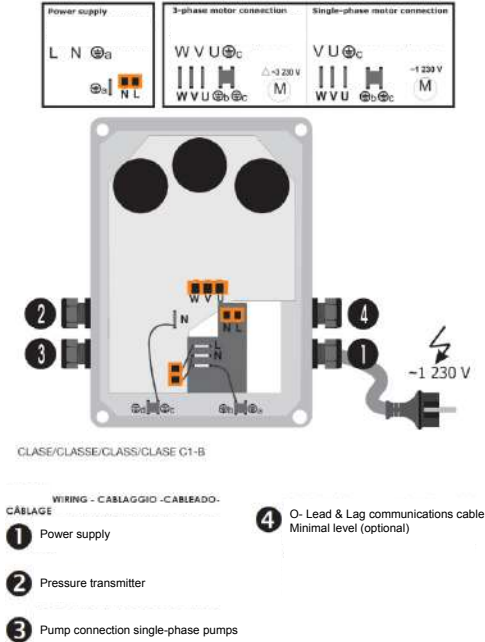

Figure 7.5

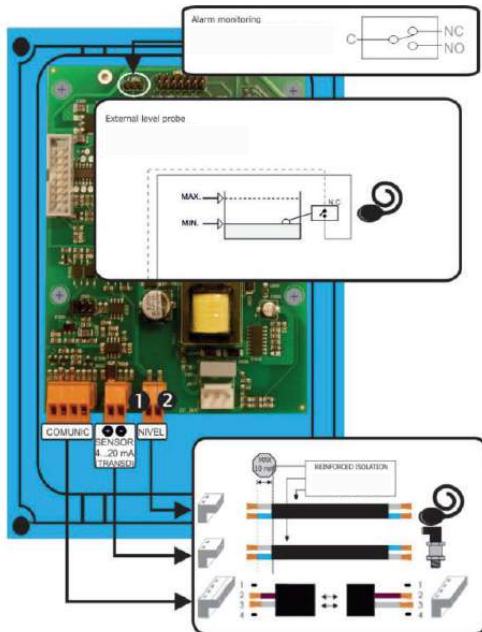



Figure 7.6

To set the DynaDrive to recognize the remote switch:

- Ensure **automated control** is turned off. To turn the automated control off, push the  **Automatic on / manual off button**.
- The green  **Automatic LED** will turn off, see figure 7.7;

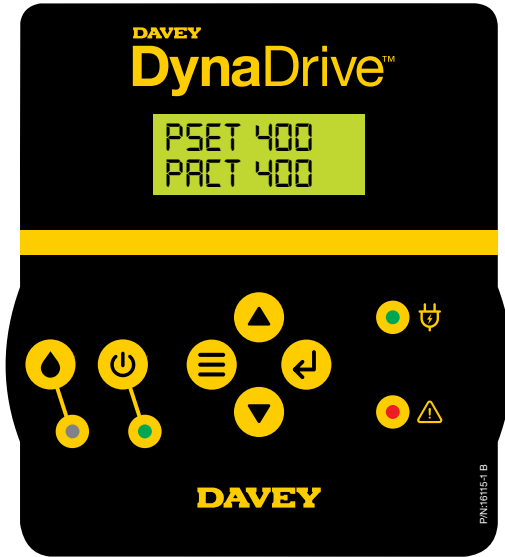

Figure 7.7



- Once the motor has slowed to a stop, press and hold the  **Menu button** and  **Enter button** for ~ 5 seconds. The display will change to show your current set pressure, see figure 7.8;



Figure 7.8

- If the controls are untouched for ~ 30 seconds, the menu will revert back to normal display;
- Using the ▲ **Menu up button** and ▼ **Menu down button** scroll through to LEVEL;
- Use the ▲ **Menu up button** and ▼ **Menu down button** to change the setting to Y;
- Press the ↵ **Enter button** to save settings and return to the HOME SCREEN;
- Now restart automatic operation by pressing ⏻ **Automatic on / manual off button**.

Once the menu has been changed to acknowledge the external float, the external float can be wired into the DynaDrive controller. The normally open terminals will not trigger fault/alarm/pause conditions. When the terminals are closed circuit, the DynaDrive operates normally. Davey recommends a float switch cable no longer than 3m (10 feet), when using 2 x 0.25mm (24 AWG) cable. If the switch overrides DynaDrive to pause, the DynaDrive display will show a flashing 🔴⚠️ **Fault LED**.

The ⏻ **Automatic LED** will also flash on the control display, see figure 7.9.



Figure 7.9

Once the switch is reversed, for example the rainwater tank filling again, the DynaDrive will restart and the display will return to normal.

7.4 Daisy-chain multiple DynaDrive systems

It is possible to run two DynaDrive pumps in parallel, with a shared discharge line. This can be particularly useful in applications where the system's maximum flow rate can be significantly higher than the system's minimum flow rate. For example: if DynaDrive needed a flow rate demand of up to 140L/min (37 gallons/min) at a pressure of 400kPa. Running two DynaDrive DD90-11 systems in parallel with common discharge would accommodate this. One DynaDrive would be designated as the LEAD, with the remaining DynaDrive designated as a LAG. Each DynaDrive would require its own pressure transducer. When making changes to settings in the system, only the LEAD can be adjusted.

On initial startup, the DynaDrive designated as the LEAD will be the first pump to start. The LAG DynaDrive will come on if the first pump is unable to maintain set pressure, even when running at 100% speed. The next time water is in demand, the LAG pump will come on first. This sequence is referred to as auto-rotate. To wire up the LEAD and LAG pump, refer figure 7.10.

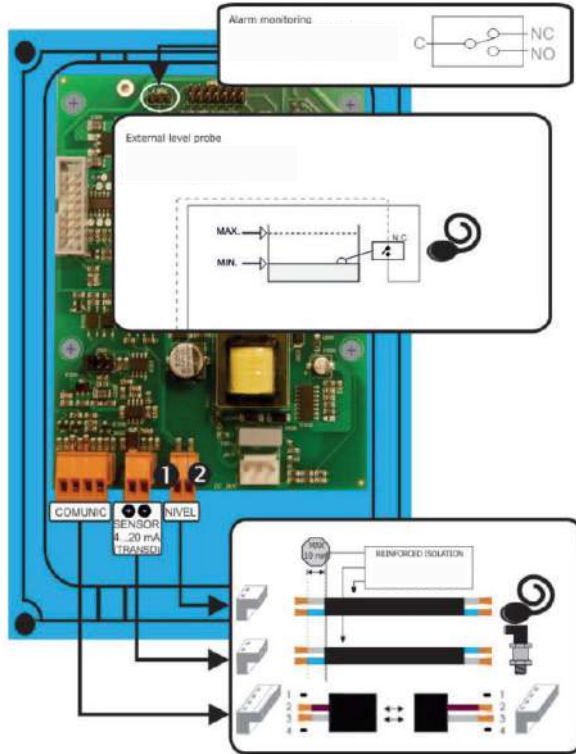











Figure 7.10

The connection between the DynaDrive controllers requires 2 x 0.25mm (24 AWG) cable. From one DynaDrive, use the "COMUNIC" terminal 2. Wire to the "COMUNIC" terminal 2 of the second DynaDrive. To complete the circuit, from one DynaDrive, use the "COMUNIC" terminal 3. Wire to the "COMUNIC" terminal 3 of the second DynaDrive. Davey suggests limiting the distance between the pumps to 2m (6½ feet). To set up multiple DynaDrive to run in a common manifolded system use the following:

To set the DynaDrive to recognise the daisy chain configuration:

- Ensure **automated control** is turned off. To turn the automated control off, push the  **Automatic on / manual off button**.
- The green  **Automatic LED** will turn off, see figure 7.8;

- Once the motor has slowed to a stop, press and hold the  **Menu button** and  **Enter button** for ~ 5 seconds. The display will change to show your current set pressure, see figure 7.9;
- If the controls are untouched for ~ 30 seconds, the menu will revert back to normal display;
- Using the  **Menu up button** and  **Menu down button** scroll through to TYPE;
- Use the  **Menu up button** and  **Menu down button** to change the setting from SINGLE to MASTER;
- Press the  **Enter button** to save settings and return to the HOME SCREEN;
- Repeat this process with the other pump in the system, selecting "SINGLE" ("slave" on models with serial # pre-dating 21100__ __);
- Now restart automatic operation by pressing  **Automatic on / manual off button**.

8. TECHNICAL SPECIFICATIONS

8.1 Operating limits

	DD60-10(CE/NPT)	DD90-11 (CE/NPT)
Max flow rate @ 300kPa (43psi)	60L/min (16 US gallons)	92L/min (24 US gallons)
Max flow rate @ 400kPa (58psi)	48L/min (13 US gallons)	72L/min (19 US gallons)
Max flow rate @ 500kPa (73psi)	32L/min (8 US gallons)	35L/min (9 US gallons)
Maximum casing pressure	1,000kPa (145psi)	
Maximum set pressure	600kPa (87psi)	
Minimum cut-in pressure (gauge)	10kPa (1½psi)	
Default cut-in pressure	50kPa (7psi) less than set pressure	
Maximum cut-in pressure	20kPa (3psi) less than set pressure	
Operating water temp range	0 – 80°C (32 - 176°F)	
Operating ambient/air temp range	0 – 50°C (32 - 122°F)	
Max humidity	95%	
Nature of fluids	Clean, clear, non-corrosive, non-flammable liquids with no fibers and little sand/ silica or abrasives (maximum concentration 40g/m³).	
Applicable approvals (DD60-10 & DD90-11)	UNE-EN 55014-1; UNE-EN 61000-3-2; UNE-EN61000-3-3; UNE-EN 55014-2; IEC 60335-2- 41; IEC 60335-1 + A1 + A2; AS/NZS 60335.2.41; AS/NZS 60335.1 + A1 + A2 + A3 + A4; AS4020	
Applicable approvals (DD60-10CE & DD90-11CE)	EN 60335-2-41 + A1 + A2 EN 60335-1 + A11 + A13 EN 62233	
Applicable approvals (DD60-10NPT & DD90-11NPT)	UL 778; UL61800-5-1; CSA-C22.2 No. 108-14	

8.2 Hydraulic performance

	DD60-10	DD60-10CE	DD60-10NPT	DD90-11	DD90-11CE	DD90-11NPT
Inlet	1¼" BSP F		1¼" NPT F	1¼" BSP F		1¼" NPT F
Discharge outlet	1" BSP M		1" NPT M	1" BSP M		1" NPT M
Default nominal operating pressure	400kPa (58psi)		60psi	400kPa (58psi)		60psi
Number of stages (impellers)	6			5		
Maximum pump pressure (head)	69m (226')			59m (194')		
Pressure tank outlet	1" BSP M	N/A	1" NPT M	1" BSP M	N/A	1" NPT M
Tank pre-charge (default)	280kPa (41psi)	N/A	290kPa (42psi)	280kPa (41psi)	N/A	290kPa (42psi)

Figure 8.1

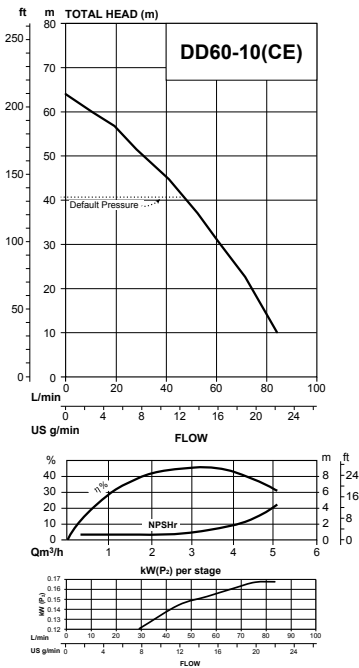

Figure 8.2

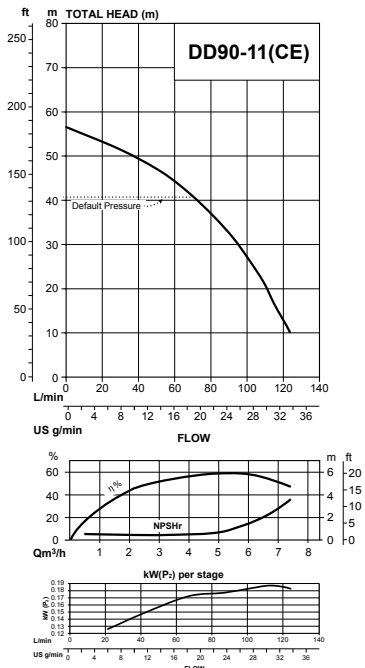

Figure 8.3

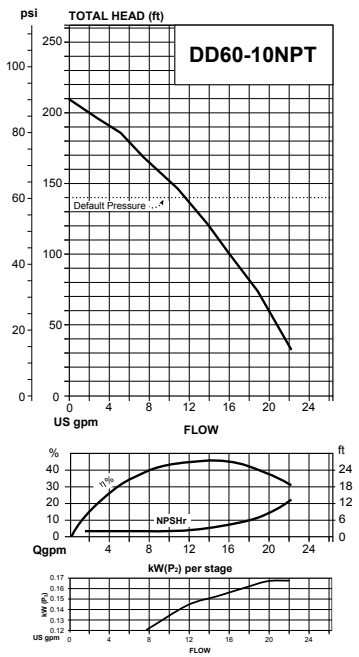
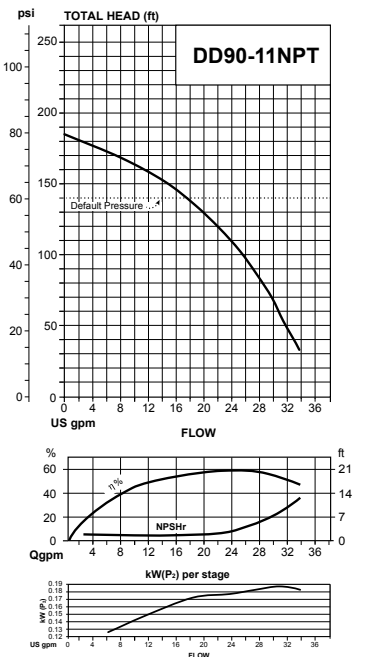

Figure 8.4



8.3 Dimensions

DD60-10

DD90-11

A	175mm (6 7/8")
B	598mm (23 1/2")
C	307mm (12")
D	149mm (5 7/8")
E	102mm (4")
F	251mm (9 7/8")
G	130mm (5 1/8")
H	258mm (10 1/8")
I	461mm (18 1/8")

Figure 8.4

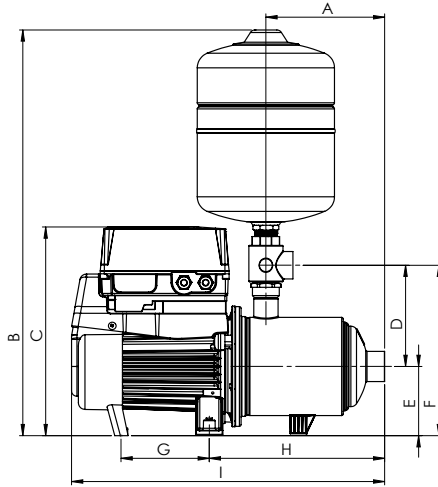

8.4 Electrical data

	DD60-10(CE/NPT)	DD90-11 (CE/NPT)
Voltage	220 – 240V ~	
Max motor speed	2,900rpm	
Frequency (incoming power)	50 – 60Hz	
Input power (P₁)	1.1kW	1.3kW
Output power (P₂)	0.8kW	0.9kW
Running current	7.4A	8.6A
Insulation class	F	
IP rating	55	

8.5 Materials of construction

PART	MATERIAL
Casing	304 stainless steel
Impellers	304 stainless steel
Stages (casing)	304 stainless steel
Pump shaft	316 stainless steel
Stage centring device	304 stainless steel

Mechanical seal (rotating)	Carbon
Mechanical seal (stationary)	Ceramic
Mechanical seal (spring)	316SS
Mechanical seal (bellows)	EPDM
O-rings	EPDM
Plugs	316 stainless steel
Motor shell and lantern bracket	Aluminium with baked polyester powder coat finish
Motor feet	Xenoy
Fan cowl/rear foot (DD60-10, DD90-11)	Polypropylene
Adaptor VSD	Polypropylene
5-way tee piece	304 stainless steel
Pump coupling to 5-way tee piece	304 stainless steel
Bearings	C3 greased and sealed for life

10. MAINTENANCE



ATTENTION: Automatic resets may allow the pump to restart without warning. Always disconnect the pump motor from the electrical supply before maintenance or repairs. When servicing or attending pump and/or controllers, always ensure power is switched off and lead unplugged. Electrical connections should be serviced only by qualified persons. If the electrical supply lead of this pressure system is damaged, it must be replaced by the manufacturer, or an appointed representative. Under no circumstances should the DynaDrive be disassembled by other than qualified tradespersons. Failure to observe this warning may expose persons to the possibility of personal injury and may also result in damage to other property. Do not dismantle spring under pressure.



IMPORTANT: Do not use hydrocarbon based or hydrocarbon propelled sprays around the electrical components of this pump. During servicing, use only approved, non-petrochemical based o-ring and gasket lubrication. If unsure, consult your Davey representative for advice. For protection, DynaDrive monitors input current and will shut down the pump motor in the event of an over load.

10.1 Periodic pressure tank checks

Depending on the quality of the pumped water, from time to time your tank may require flushing to remove settled fines such as mud or sand. If sand, or mud can stay in the tank it will accelerate wear on the internal lining and shorten your tanks life. Safely disconnect the tank from the water supply, discharge all air from the tank and flush the tank several times with clean water. Once the flushing water is clean, reconnect the tank and recharge the air as described in the pressure tank section of the installation chapter.

A tank in good order will not leak, but over time due to damage through rough handling, impacts or grit and/or impurities in the water the tank shell may fail and/or leak. Should the tank leak or show signs of possible failure the tank should be immediately disconnected and replaced.

11. TROUBLESHOOTING

Symptom	Potential Fix
<ul style="list-style-type: none"> • Fault light flashes on DynaDrive display; • “A1 DRY RUN” shows on DynaDrive display; • DynaDrive attempts restart after 5 minutes; • DynaDrive attempts restart in 30 minutes intervals, for 25 hours; • DynaDrive then reverts to solid alert with no further retry. 	<p>DynaDrive has run dry or lost prime. To protect itself, DynaDrive has switched off. Before trying to restart: turn off the DynaDrive for 30 seconds; ensure the pump has cooled down (if hot); then restart as per section 6 of this manual. If problem persists, contact your Davey representative via the details at the end of this manual.</p>
<ul style="list-style-type: none"> • “A5 TRANSDU” 	<p>Transducer is disconnected from the Drive. Reconnect the pressure transducer to the quick connect cable attached to the pump.</p>
<ul style="list-style-type: none"> • Fault light flashes on DynaDrive display; • “A6 OVER TEMP” shows on DynaDrive display; and • DynaDrive attempts random restarts. 	<p>DynaDrive has detected high temperature inside controller. To protect itself, DynaDrive has switched off. Before trying to restart: turn off the DynaDrive for 30 seconds; ensure the pump has cooled down (if hot); then restart as per section 6 of this manual. If problem persists, contact your Davey representative via the details at the end of this manual.</p>
<ul style="list-style-type: none"> • A7 SHORTCIRCUIT • the pump stops and then it starts again - performing 4 successive attempts. If the problem is not solved, the pump will remain definitely out of order. 	<p>The device has an electronic system for protection against short circuits as well as peaks of current. Check the pump, if the problem persists, contact your Davey representative via the details at the end of this manual.</p>
<ul style="list-style-type: none"> • Fault light flashes on DynaDrive display; • “A8 OVER VOL” shows on DynaDrive display; and • DynaDrive attempts random restarts. 	<p>DynaDrive has detected high voltage. To protect itself, DynaDrive has switched off. Before trying to restart: turn off the DynaDrive for 30 seconds; ensure the pump has cooled down (if hot); then restart as per section 6 of this manual. If problem persists, contact your Davey representative via the details at the end of this manual.</p>
<ul style="list-style-type: none"> • Fault light flashes on DynaDrive display; • “A9 UNDER VOL” shows on DynaDrive display; • DynaDrive attempts restart 4 times; then • DynaDrive reverts to solid alert with no further retry. 	<p>DynaDrive has detected low voltage, or high current draw. To protect itself, DynaDrive has switched off. Before trying to restart: turn off the DynaDrive for 30 seconds; ensure the pump has cooled down (if hot); then restart as per section 6 of this manual. If problem persists, contact your Davey representative via the details at the end of this manual.</p>
<ul style="list-style-type: none"> • DynaDrive display screen blank. 	<p>DynaDrive communication failure. Refer to section 7.4 of this manual to check connections and settings. If problem persists, contact your Davey representative via the details at the end of this manual.</p>
<ul style="list-style-type: none"> • Daisy chained pumps operating as individual pumps. 	<p>DynaDrive communication failure. Refer to section 7.4 of this manual to check connections and settings. If problem persists, contact your Davey representative via the details at the end of this manual.</p>

12. SPARE PARTS

DynaDrive 6 stages	DD60-10(CE)	DD60-10NPT
DynaDrive 5 stages	DD90-11(CE)	DD90-11NPT

Notes: A. 2nd Stage body comes with air valve assy which can be retrofitted onto models without the air valve. Subsequent stage bodies have the air hole which can also be retrofitted onto models that do not have the air valve already fitted.

B. Washer cup part number 13666 - quantity of 1 required for HM60 & HM90 models (fitted to drive end side only).

C. Tank is optional extra for CE and NPT model variants

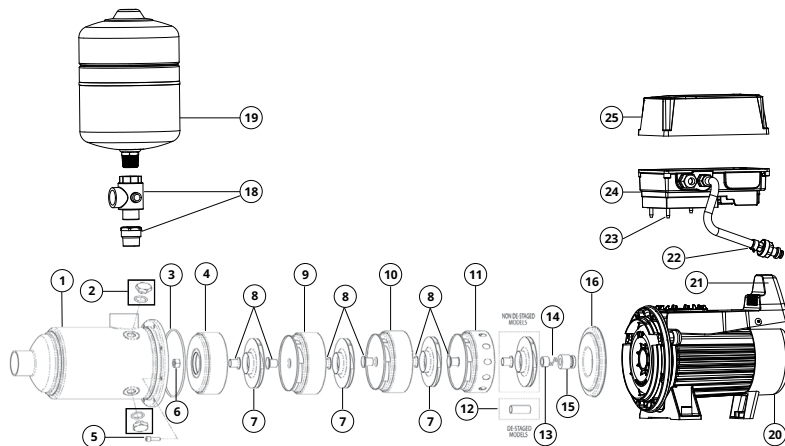

ITEM	NOTES	DESCRIPTION	QTY REQ'D	PART NO.
1		Casing - Front DD60-10(CE), DD90-11(CE)	1	13656-6SP
1		Casing - Front DD60-10NPT, DD90-11NPT	1	13656-6USA
2		Plug & O-ring - 1/4" BSP Vertical	3	400577SP
3		O-ring - Casing	1	44853
4		Stage body - 1st stage	1	13661-1
5		Screw - Casing (pk8)	1	S34M0616*8
6		Nut - Casing 6mm s/s	1	N33M10*6
6		Nut - Half	1	401573
7		Impeller DD60 series	As required	13678
7		Impeller DD90 series	As required	13676
8		Spacer - Impeller	As required	13665
9	A	Stage Body - 2nd stage with valve assy	1	32912
10		Stage body - Inner stages	As required	13662-2
11		Stage body - Final	1	13663
12		Spacer - Destage	1	13696-1
13	B	Washer - Cup	As required	13666
14		Clip spring	2	13667
15		Seal - Mechanical	1	400558SP
16		Backplate	1	13660
18		Outlet Assembly DD60-10(CE), DD90-11(CE)	1	33080
18		Outlet Assembly DD60-10NPT, DD90-11NPT	1	33080NPT
19		8L NPT Pressure Tank DD60-10NPT, DD90-11NPT	1	33076NPT
19		8L pressure tank DD60-10(CE), DD90-11(CE)	1	24008P
20		Fan cowl DD60-10(CE), DD90-11(CE)	1	11150-40M
20		Fan cowl DD60-10NPT, DD90-11NPT	1	11150-40MNPT
21		VSD adaptor	1	16098
22		Pressure transducer & loom	1	RECH092SP
23		O-ring to suit adaptor VSD	1	402442
24		DynaDrive power module DD60-10(CE), DD90-11(CE)	1	RECH092345SP
24		DynaDrive power module DD60-10NPT, DD90-11NPT	1	RECH102
25		DynaDrive control module DD60-10(CE), DD90-11(CE)	1	RECH0915P
25		DynaDrive control module DD60-10NPT, DD90-11NPT	1	RECH103
-		Slinger - Water	1	13648

Figure 11.1

Cont. overleaf...

13. Davey Warranty

13.1 Warranty Inside the USA

Davey Water Products come with guarantees that cannot be excluded under the local country Law. You are entitled to a replacement, or refund for a major failure and compensation for any other reasonably foreseeable loss, or damage. You are also entitled to have the goods repaired or replaced if the goods fail to be of acceptable quality and the failure does not amount to a major failure.

Davey Water Products Pty Ltd (Davey) of 6 Lakeview Drive Scoresby VIC 3179 provides the following warranty in relation to this product:

1. The guarantee period commences on either the date of installation or the original purchase of the equipment (whichever is the later). Evidence of this date must be provided when claiming repairs under guarantee. It is recommended you retain all receipts in a safe place.
2. Davey products are warranted, subject to the exclusions and limitations below, to the original user only to be free of defects in material and workmanship for a period of 36 months from date of installation or sale with a proof of a receipt, but no more than 48 months from the date of manufacture. Davey's liability under this warranty shall be limited to repairing or replacing at Davey's option, without charge, FOB Davey's authorized service agent. Davey will not be liable for any cost of removal, installation, transport or any other charges that may arise in connection with the warranty claim. Product eligible for repair or replacement by the authorized Davey service agent, in accordance with Davey's warranty terms, shall be shipped back to the customer from the service center at Davey's cost.
3. This guarantee is subject to due compliance by the original purchaser with all directions and conditions set out in the Installation and Operating Instructions. Failure to comply with these instructions, damage or breakdown caused by fair wear and tear, negligence, misuse, accident, incorrect installation, inappropriate chemicals or additives in the water, inadequate protection against freezing, rain or other adverse weather conditions, corrosive or abrasive water, lightning or high voltage spikes or through unauthorized persons attempting repairs are not covered under guarantee. The product must only be connected to the voltage shown on the nameplate.
4. Davey shall not be liable for any loss of profits or any consequential, indirect or special loss, damage or injury of any kind whatsoever arising directly or indirectly from the product or any defect, and the purchaser shall indemnify Davey against any claim by any other person whatsoever in respect of any such loss, damage or injury.
5. Some states do not allow the exclusion or limitation of incidental or consequential damages or limitations on how long an implied warranty lasts, so the above limitations or exclusions may not apply to you. The warranty gives you specific legal rights and you may also have other rights which vary from state to state.
6. This guarantee applies to all states and territories of United States of America and Canada only.

® Davey and Torrium are registered trademarks of Davey Water Products Pty Ltd.

© Davey Water Products Pty Ltd 2020.

USA

Have installation questions or problems?

Need warranty?

Before returning this product to your dealer contact a Davey Authorized Service Centre in the USA by calling

1-888-755-8654 or visit daveywater.com

13.2 Warranty Outside the USA

Davey Water Products Pty Ltd (Davey) warrants all products sold will be (under normal use and service) free of defects in material and workmanship for a minimum period of one (1) year from the date of original purchase by the customer as marked on the invoice, for specific warranty periods for all Davey products visit daveywater.com.

This warranty does not cover normal wear and tear or apply to a product that has:

- been subject to misuse, neglect, negligence, damage or accident
- been used, operated or maintained other than in accordance with Davey's instructions
- not been installed in accordance with the Installation Instructions or by suitably qualified personnel
- been modified or altered from original specifications or in any way not approved by Davey
- had repairs attempted or made by other than Davey or its authorised dealers
- been subject to abnormal conditions such as incorrect voltage supply, lightning or high voltage spikes, or damages from electrolytic action, cavitation, sand, corrosive, saline or abrasive liquids,

The Davey warranty does not cover replacement of any product consumables or defects in products and components that have been supplied to Davey by third parties (however Davey will provide reasonable assistance to obtain the benefit of any third-party warranty).

To make a warranty claim:

- If the product is suspected of being defective, stop using it and contact the original place of purchase. Alternatively, phone Davey Customer Service or send a letter to Davey as per the contact details below
- Provide evidence or proof of date of original purchase
- If requested, return the product and/or provide further information with respect to the claim. Returning the product to the place of purchase is at your cost and is your responsibility.
- The warranty claim will be assessed by Davey on the basis of their product knowledge and reasonable judgement and will be accepted if:
 - a relevant defect is found
 - the warranty claim is made during the relevant warranty period; and
 - none of the excluded conditions listed above apply
- The customer will be notified of the warranty decision in writing and if found to be invalid the customer must organise collection of the product at their expense or authorise its disposal.

If the claim is found to be valid Davey will, at its option, repair or replace the product free of charge.

The Davey warranty is in addition to rights provided by local consumer law. You are entitled to a replacement or refund for a major failure and compensation for any other reasonably foreseeable loss or damage. You are also entitled to have the goods repaired or replaced if the goods fail to be of acceptable quality and the failure does not amount to a major failure.

For any internet connected products the consumer is responsible for ensuring a stable internet connection. In the event of a network failure the consumer will need to address the concern with the service provider. Use of an App is not a substitute for the User's own vigilance in ensuring the product is working to expectation. Use of a Smart Product App is at the User's own risk. To the fullest extent permitted by law Davey disclaims any warranties regarding the accuracy, completeness or reliability of App data. Davey is not responsible for any direct or indirect loss, damage or costs to the User arising from its reliance on internet connectivity. The User indemnifies Davey against any claims or legal actions from them or others relying on internet connectivity or App data may bring in this regard.

Products presented for repair may be replaced by refurbished products of the same type rather than being repaired. Refurbished parts may be used to repair the products. The repair of your products may result in the loss of any user-generated data. Please ensure that you have made a copy of any data saved on your products.

To the fullest extent permitted by law or statute, Davey shall not be liable for any loss of profits or any consequential, indirect or special loss, damage or injury of any kind whatsoever arising directly or indirectly from Davey products. This limitation does not apply to any liability of Davey for failure to comply with a consumer guarantee applicable to your Davey product under local laws and does not affect any rights or remedies that may be available to you under local laws.

For a complete list of Davey Dealers visit our website (daveywater.com) or call:

DAVEY

Davey Water Products Pty Ltd
Member of the GUD Group
ABN 18 066 327 517

daveywater.com

AUSTRALIA

Head Office
6 Lakeview Drive,
Scoresby, Australia 3179
Ph: 1300 232 839
Fax: 1300 369 119
Email: sales@davey.com.au

NEW ZEALAND

7 Rockridge Avenue,
Penrose, Auckland 1061
Ph: 0800 654 333
Fax: 0800 654 334
Email: sales@dpw.co.nz

EUROPE

7 rue Eugène Hénaff 69200
Vénissieux, France
Ph: +33 (0) 4 72 13 95 07
Fax: +33 (0) 4 72 33 64 57
Email: info@daveyeurope.eu

NORTH AMERICA

Ph: 1-888-755-8654
Email: info@daveyusa.com

MIDDLE EAST

Ph: +971 50 6368764
Fax: +971 6 5730472
Email: info@daveyuae.com



DAVEY

RainBank®

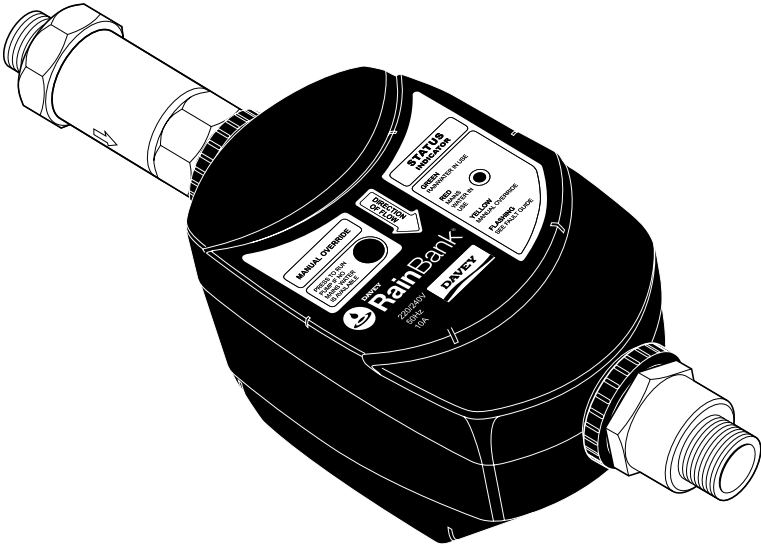

- INSTALLATION
- OPERATION
- TROUBLE SHOOTING

For any assistance or after sales service contact your Davey Dealer. For help in locating your closest Dealer contact your appropriate Davey Support Centre listed on the back of this booklet.



WaterMark

WM15-477-2016 Lic: WM-022042

DAVEY

DAVEY

Davey commenced in 1934 and today, as Davey Water Products, manufactures and distributes a comprehensive range of products for transfer, conservation, treatment and filtration of water.

Davey has a dominant market share in Australia and exports to more than 50 separate countries, servicing some of the toughest environmental and climatic conditions on the globe.

Davey has maintained its commitment to research and development, resulting in innovative new products servicing specific and emerging market opportunities. Many of these products have received multiple awards for innovation and excellence which have led to our induction into the Manufacturing Hall of Fame in Victoria.

Davey maintains leadership in quality with an environmental focus by holding ISO 9000-2001 accreditation and ISO 14000 environmental standard.

Davey is today a wholly owned subsidiary of GUD, a 'Top 200' Australian public company whose shares are listed on the Australian Stock Exchange.

Now more than ever "Depend on Davey" reflects a business culture of dependable, innovative water solutions when and where you need them, supported by the best service and advice.

CONTENTS

About RainBank. The easy way to save water.	4
Two types of installation - quick reference	5
How RainBank works	6
How to install RainBank	7
Before you start	9
Installation instruction	11
Pump outside tank option	12
Pump inside tank option	14
Float switch installation	18
Installation of Submersible Pumps	25
Priming Pumps	26
Maintaining RainBank	28
Trouble shooting RainBank	29
Warnings	32
Plumbers Tips	33
Davey Guarantee	35
Contact Details	36

ABOUT RAINBANK THE EASY WAY TO SAVE WATER

Congratulations on your purchase of a high quality Australian made Davey RainBank automatic water controller. RainBank is patented and has been fitted to thousands of homes.

- RainBank allows you to use water from your rainwater tank for your toilet, washing machine or garden whenever there is water in the tank.
- If the tank water is exhausted RainBank automatically and seamlessly switches you over to mains water.
- RainBank has an in-built “dual check valve” for low hazard backflow prevention.

RainBank can save up to 40% of your home's usage of mains water, which could be up to 100,000 litres of water a year.

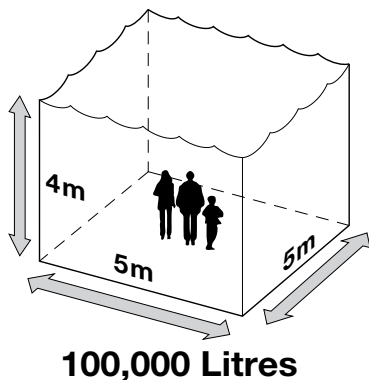

Your actual savings depend on your roof catchment area, rainfall and the size of your tank.

RainBank may allow you to claim tank rebates (when installed on existing homes). Check with your local water authority.

In some areas of Australia, having a RainBank and using rainwater for your toilet and washing machine allows you to claim tank rebates paid by state governments and some councils.

RainBank is energy efficient and cheap to run.

Because RainBank only works when it is needed it uses very little energy.

The daily power used to run a RainBank and pump system supplying two toilets in a three person dwelling is equivalent to:

- A reverse cycle air conditioner for 3 minutes
- A clothes dryer for 3 minutes
- A washing machine for 10 minutes
- A TV or PC for 30 minutes

TWO TYPES OF INSTALLATION

IN-TANK OPTION MODEL NO. KRBS1 & 2

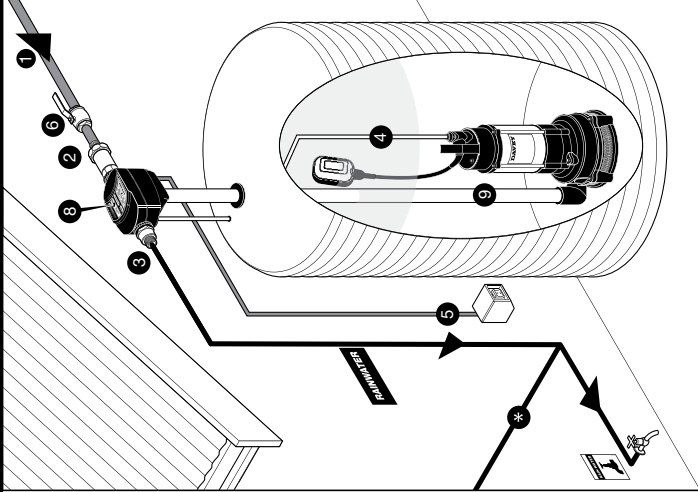

In-tank Option Model No. KRBS1&2

(see page 14)

ABOVE GROUND OPTION MODEL NO. KRB1, 2, 3 & 4

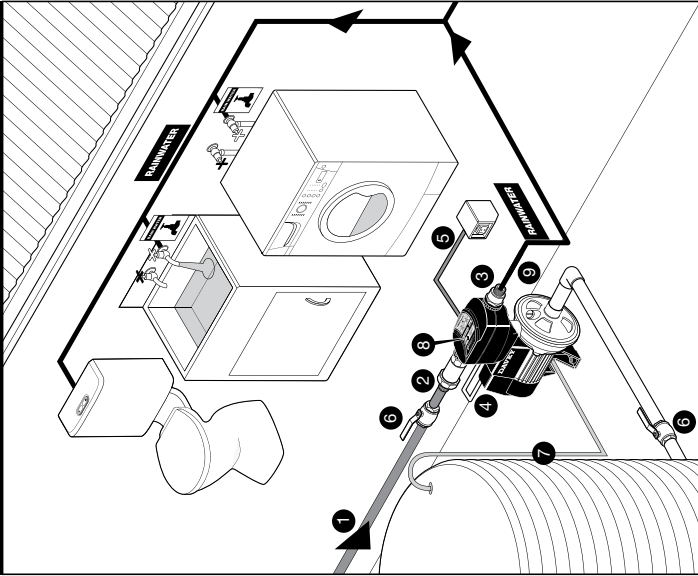

Above Ground Option Model No. KRB1,2,3&4

(see page 12)

- 1 Mains water supply
600kPa Maximum
 - 2 3/4" BSP Male thread
 - 3 3/4" BSP Male thread
 - 4 Pump Power lead
 - 5 RainBank Power lead
 - 6 Stop valve
 - 7 Float switch
 - 8 Manual start button
 - 9 Rainwater supply via pump
- * Warning:**
Do not reconnect with
mains water supply
- ! Important:**
All pipework and outlet
fittings from RainBank must
be labelled to AS/NZS 3500.1

HOW RAINBANK WORKS

1. When there is demand for water from your toilet, washing machine or garden tap, RainBank senses this demand and checks the level of water in the rainwater tank.
Note: demand must be greater than 1.5 litres per minute or mains water will be delivered.
2. If there is rainwater in the tank RainBank switches on the pump. The pressure of the pump is sufficient to overcome the pressure of the mains water inside RainBank and this moves a plunger and allows the rainwater to flow.
Note: mains water pressure is not restricted.
3. When there is no longer a demand for water, RainBank detects that water has ceased to move inside the pipes, switches off the pump and waits for another water demand.
4. If RainBank senses a water demand and detects insufficient water in the rainwater tank it will automatically allow the mains water to flow.
5. If there is a power failure during a demand for water RainBank will automatically supply the mains water as backup.

What are the advantages of RainBank over conventional air-gap systems?

- RainBank is totally hands off and needs no maintenance or adjustment.
- RainBank is easy to install.
- RainBank does not require mains water to be re-pumped and therefore saves energy.
- RainBank is WaterMark approved – this means plumbing inspections will be approved & your plumbers insurance should cover installation faults.
- RainBank will provide mains water as backup when:
 - there is no rainwater
 - there is no electricity to run pump
 - the pump has been removed for servicing. Air-gap systems rely on pumps to pressurise all water and do not function without them.

HOW TO INSTALL RAINBANK

⚠ IMPORTANT

Because it involves mains water, RainBank may only be legally installed by a licensed plumber. Ensure mains water pressure is limited to 600kPa.

NOTE: Because the effects of seasonal change etc. can cause the pump and tank to move slightly relevant to the home it is highly recommended that discharge and/or suction pipe lines be fitted with flexible pipe, such as braided hose, reinforced suction hose or polythene pipe.

Different types of RainBank Installations

There are different ways a RainBank can be installed depending on your rainwater tank and pump configuration.

INSTALLATION TYPE 1 - PAGE 16

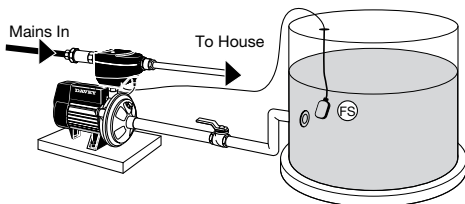

Tank: above ground

Pump: outside tank

Float switch: must be installed inside of tank

Pump Kit: KRB1, 2, 3 & 4

INSTALLATION TYPE 2 - PAGE 21

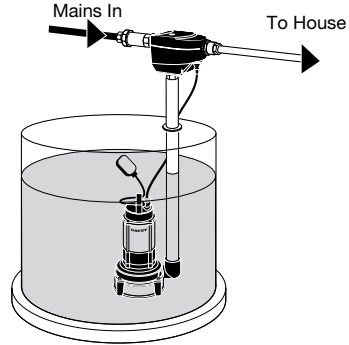

Tank: above ground

Pump: submersible inside tank

Float switch: incorporated with pump

Pump Kit: KRBS1 & 2

INSTALLATION TYPE 3 - PAGE 22

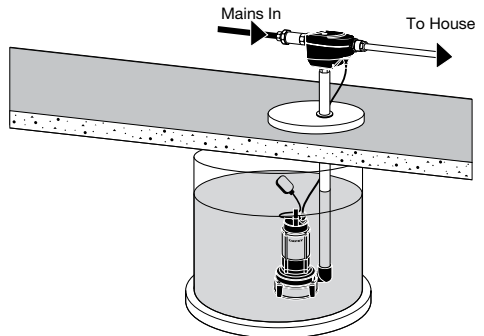

Tank: below ground

Pump: submersible inside tank

Float switch: incorporated with pumps

Pump Kit: KRBS1 & 2

INSTALLATION TYPE 4 - PAGE 23

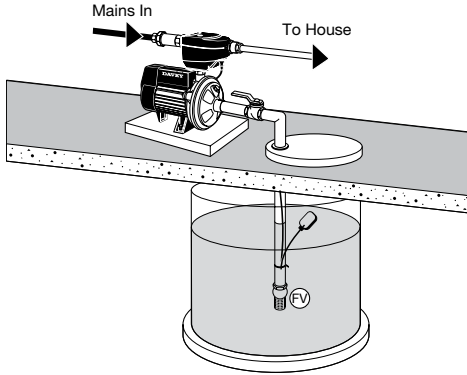

Tank: Below ground and at ground level

Float switch: Top entry

Pump Kit: KRB1, 2, 3 & 4

Different ways of installing the RainBank unit itself.

- Exposed installation against wall (under eaves).

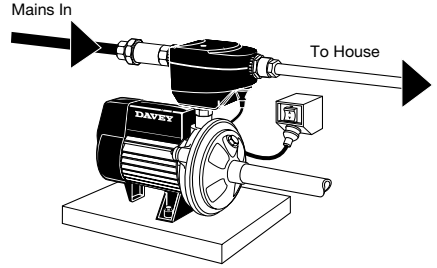

- Encased installation with unit and pump inside cover.

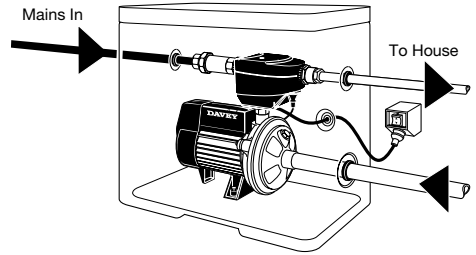

- Integrated installation incorporated as part of tank system.

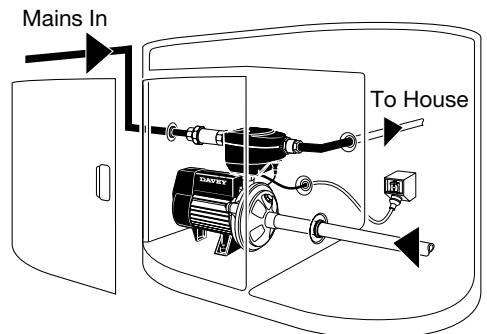

BEFORE YOU START



IMPORTANT:

- If you are in doubt about any aspect of your RainBank kit's suitability, check with your Davey Dealer. For help in locating your closet Dealer call the appropriate Davey Customer Service Centre listed on the back of this booklet.
- RainBank is designed to handle clean rainwater and mains water. It should not be used to interconnect as part of a bore water, dam water, grey water, stormwater or recycled water system without appropriate additional backflow.
- Make sure the wiring, plumbing and the RainBank unit are protected from access by children and pets.

Other things we recommend to maximise the performance and serviceability of your RainBank.

- Fit a first flush system to the guttering if possible to divert the initial run of water from the roof that may contain dirt and pollutants.
- Fit a strainer to the top of your tank inlet to stop leaves entering the system.
- Fit a 1 inch 'Y' strainer with 200 micron mesh to the pipe work between the pump and RainBank. This will ensure that debris from the tank will not build up inside RainBank, washing machines or toilet cisterns.
- Use at least 20mm or ¾ inch plumbing to and from RainBank to reduce the effect of pipe friction. Galvanised pipe not recommended.

Make sure the delivery from RainBank to your home is within the following pipe length limits:

Pipe diameter	Max. pipe length @ 6 lpm flow	Max. pipe length @ 12 lpm flow
15mm	1m	1m
18mm	90m	27m
20mm	235m	135m

For each bend or tee you should reduce the above distances by 0.5m.

- We recommend fitting isolation valves to the rainwater and mains water pipe so that the RainBank can be easily and conveniently removed if required. This saves both wasting rainwater and having to turn off the mains supply if the unit ever has to be removed.
- While RainBank does have an in-built DUAL CHECK back flow prevention valve, some water authorities require an additional external back flow valve to be plumbed into the mains water delivery line, to prevent any possible contamination of mains water by rainwater, particularly if the tank is partially or fully submerged. Check with your local water authority for their plumbing guidelines on rainwater tanks.

- Double check valve assemblies are available from Davey and should be installed if the tank is partially or fully buried.
- Mains water must be limited to below 600kPa.

INSTALLATION INSTRUCTIONS

Things you should be aware of:

- Before installing RainBank please read all instructions carefully as failures caused by incorrect installation are not covered under warranty.
- RainBank is designed to handle clean water and should not be used for any other purpose without specific referral to Davey. The use of RainBank to pump flammable, corrosive or other materials of a hazardous nature will damage the system and void the warranty.
- The pumping of abrasive materials will damage the system and void the warranty.
- Water freezing inside the RainBank will damage the unit. Locate your RainBank and pump so that they are not susceptible to freezing.
- Some insects such as small ants find electrical devices attractive for various reasons. If your controller or pump is susceptible to insect infestation you should implement a suitable pest control plan.
- **Limit mains water pressure to 600kPa.**
- An inline 'Y' strainer between the pump and the RainBank controller is recommended to stop foreign matter entering the unit and damaging it.
- All pipe work and fittings should be labelled in accordance with local standards such as Australian Standard AS/NZS 3500.1. This standard requires that all pipework containing rainwater is marked with green 'rainwater' tape or stickers at 1 meter intervals and every outlet that may deliver rainwater is to be permanently signed with 'Rain Water' signage or a green tap marked 'RW'.
- Ensure all wiring, plumbing and the RainBank unit are protected from access by pets and/or children.
- Mains electrical connections and checks must be made by a qualified electrician and comply with applicable local standards. The 5 volt float lead connections need not be carried out by a qualified electrician, but should be done in compliance with applicable standards.
- In accordance with AS/NZS 60335.2.41 we are obliged to inform you that this controller and any pump controlled by it is not to be used by children or infirm persons and must not be used as a toy by children.

PUMP OUTSIDE TANK OPTION - OVERALL

MODEL NO. KRB1, 2, 3 & 4

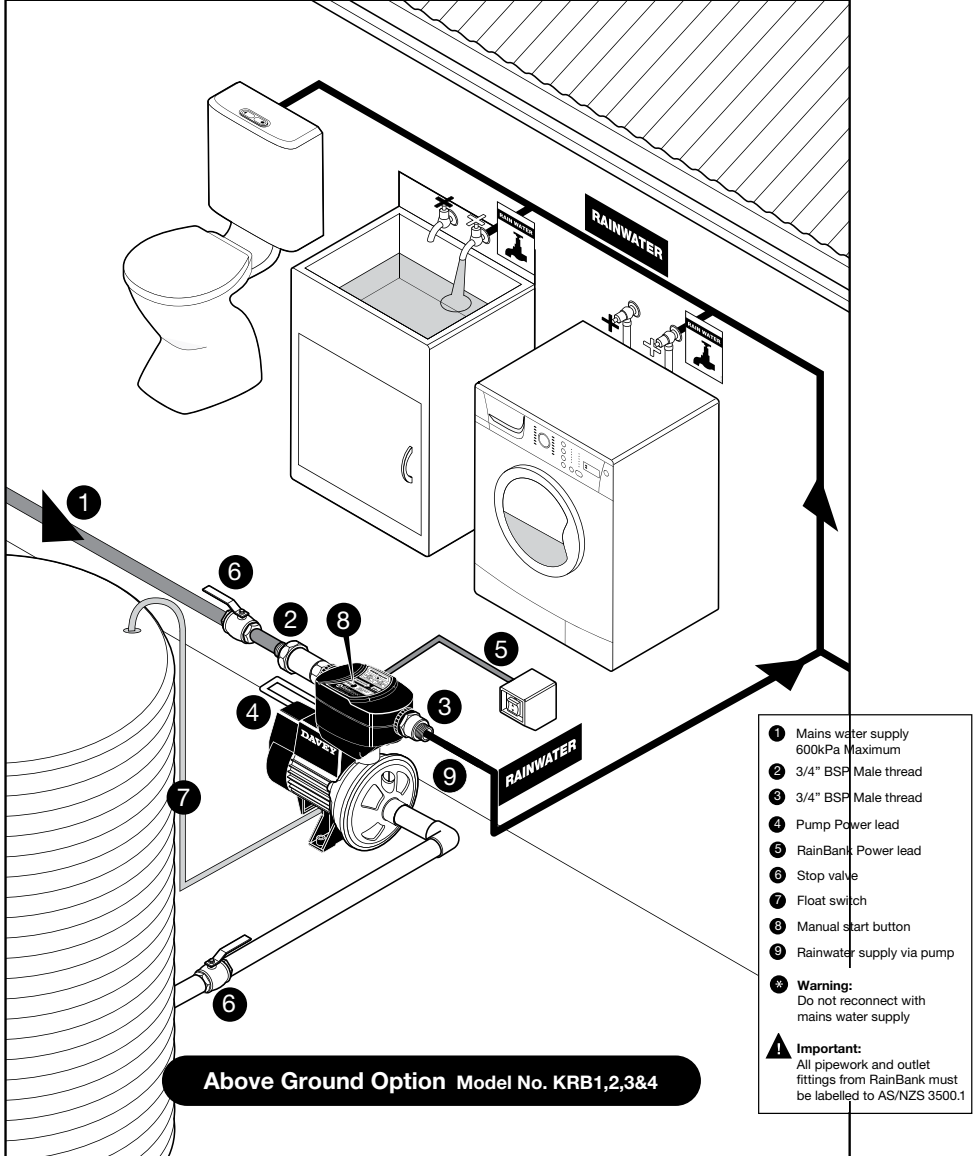

Above Ground Option Model No. KRB1,2,3&4

PUMP OUTSIDE TANK OPTION - CLOSE UP



IMPORTANT: ALL PIPEWORK AND OUTLET FITTINGS FROM RAINBANK MUST BE LABELLED TO AS/NZS 3500.1. TANK MUST HAVE ISOLATION VALVE FITTED. DO NOT CONNECT WITH CRIMPED FITTINGS.

RainBank MUST BE INSTALLED HORIZONTALLY AS ILLUSTRATED.

WHERE MAINS PRESSURE EXCEEDS 600kPa. A PLV* MUST BE FITTED TO INLET!

* Pressure Limiting Valve
NOTE: Australian Building Standards stipulate incoming mains pressure should not exceed 500kPa.

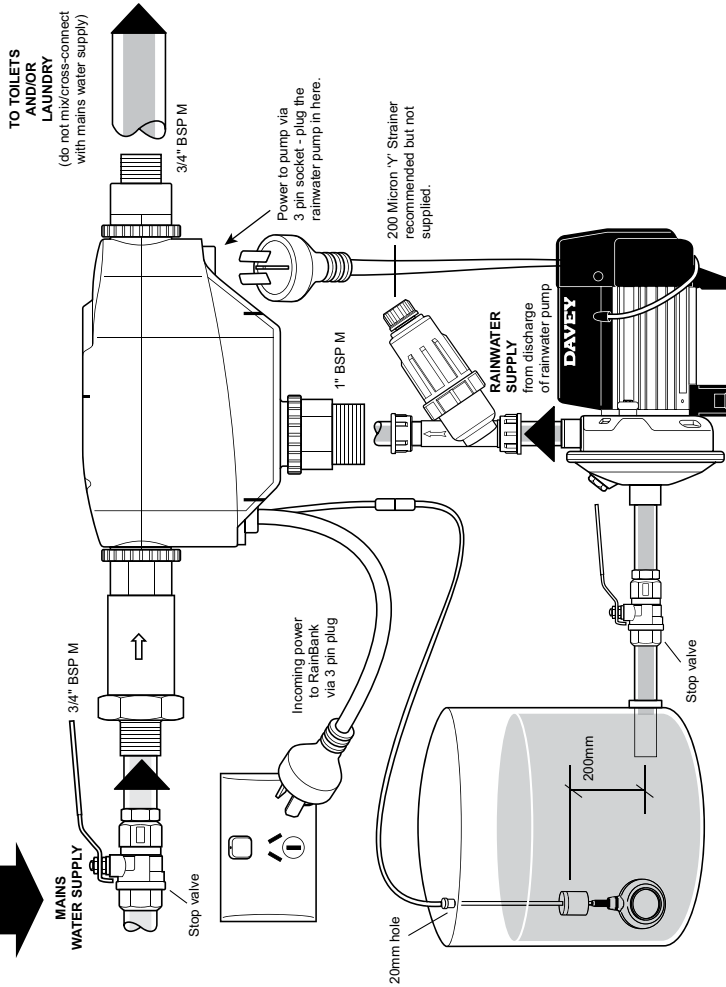

WARNING: DO NOT FIT CHECK VALVES BETWEEN RAINBANK, PUMP AND TANK. UNLESS PUMP IS ABOVE MAXIMUM WATER LEVEL OF TANK.

PUMP INSIDE TANK OPTION - OVERALL

MODEL NO. KRBS1 & 2

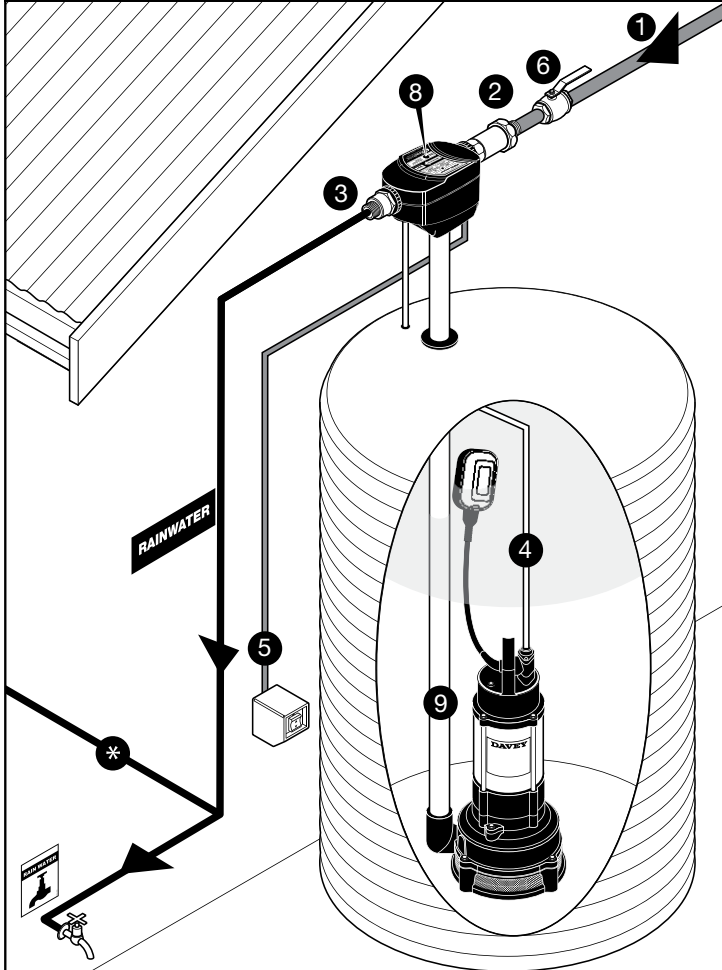

In-tank Option Model No. KRBS1&2

- 1 Mains water supply
600kPa Maximum
 - 2 3/4" BSP Male thread
 - 3 3/4" BSP Male thread
 - 4 Pump Power lead
 - 5 RainBank Power lead
 - 6 Stop valve
 - 7 Float switch
 - 8 Manual start button
 - 9 Rainwater supply via pump
- *** **Warning:**
Do not reconnect with
mains water supply
- !** **Important:**
All pipework and outlet
fittings from RainBank must
be labelled to AS/NZS 3500.1

PUMP INSIDE TANK OPTION - CLOSE UP



IMPORTANT: ALL PIPEWORK AND OUTLET FITTINGS FROM RAINBANK MUST BE LABELLED TO AS/NZS 3500.1. DO NOT CONNECT WITH CRIMPED FITTINGS.

RainBank MUST BE INSTALLED HORIZONTALLY AS ILLUSTRATED.

WHERE MAINS PRESSURE EXCEEDS 600kPa. A PLV* MUST BE FITTED TO INLET!

NOTE: Australian Building Standards stipulate incoming mains pressure should not exceed 500kPa.

* Pressure Limiting Valve

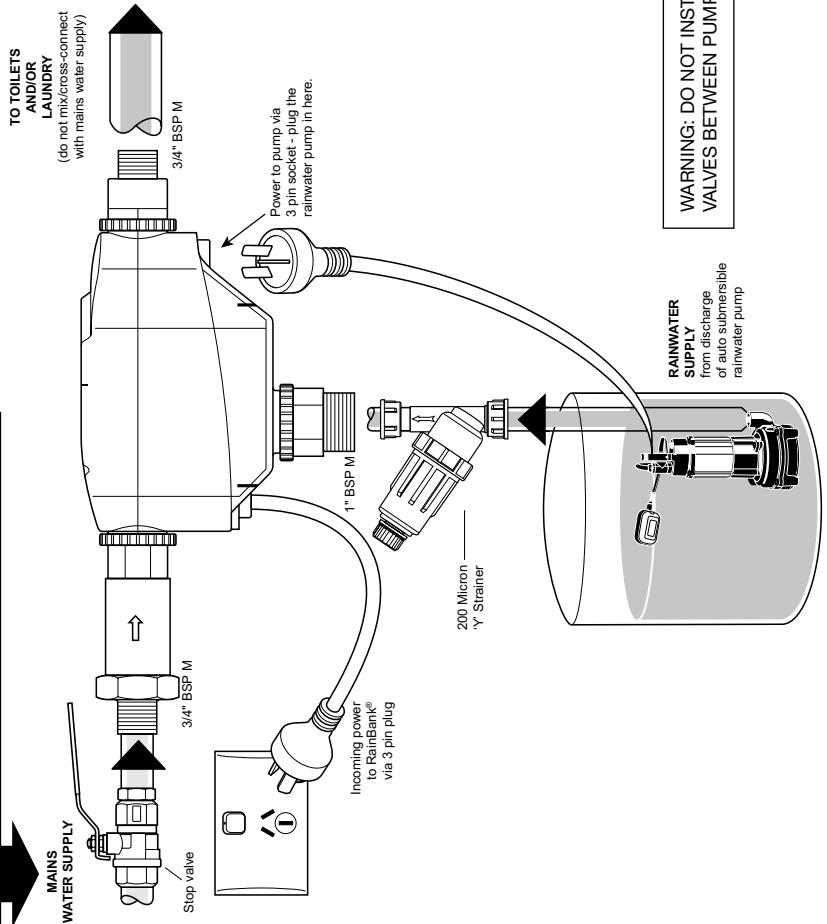

WARNING: DO NOT INSTALL CHECK VALVES BETWEEN PUMP AND RAINBANK.

RAINWATER SUPPLY
from discharge of auto submersible rainwater pump

INSTALLATION TYPE 1

Above ground tank and pump outside tank. Suitable kit models: KRB1, 2, 3 & 4

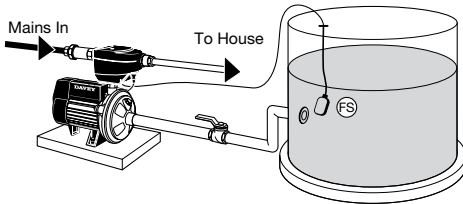

Tools you will need

- Adjustable spanner 2" or 50mm (across flats)
- Second adjustable spanner 2" or 50mm (across flats)
- Thread tape
- 20mm spade bit or hole saw to drill hole in top of tank for float switch.
- If you are mounting the RainBank to a wall as a bare installation you will need the Davey RainBank wall mounting bracket (p/n: 32556).

STEP 1 - PUMP POSITION

Evaluate and select the best pump site. This must be below the lowest anticipated level of the float switch and this level should be at least 100mm above the base of the tank to avoid sludge being drawn into the pump.

The pump site should be well drained and have a firm base. A concrete slab 600mm x 600mm is ideal.

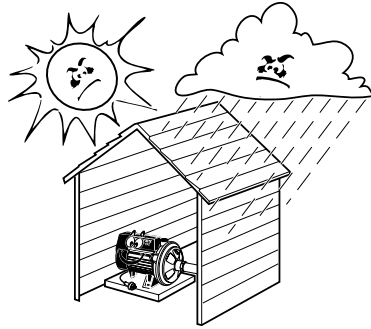

STEP 2 - RAINBANK POSITION

Work out where the RainBank will be positioned. Check that there is a power point within reach of the **3 metre power lead**.



Installation Inside Buildings: To cater for possible plumbing leaks or damage to the RainBank system components, the installation must include an enclosure that will capture any water spraying from the plumbing or RainBank system and direct it into a properly constructed drain tray.



Note: When installing a RainBank and/or associated pump system inside a building, allowance for possible high pressure leakage **MUST** be made.



Note: In order to carry out routine maintenance to the RainBank **MUST** be easily accessible to the end user or home owner.



IMPORTANT

Do not use long mains power extension leads as they cause substantial voltage drop, poor performance and can lead to motor overload.

Check that the float switch lead (9m long) will reach the RainBank.

For greater distances between your rainwater tank and pump, a 10m float switch (top and side entry) extension lead (Davey Part No. 14186) will need to be added. Up to 4 float switch extension leads can be added between the pump and the rainwater float switch lead. It is recommended that the float switch extension lead/s are in a protective conduit.

STEP 3a - TOP ENTRY FLOAT SWITCH

NOTE: THE VERTICAL POSITION OF THE FLOAT SWITCH IN RELATION TO THE PUMP WATER INLET IS CRITICAL

1. Measure the distance from the top of the tank (A) to the highest point of the tank outlet to the pump (B).
2. Mark on the float switch cable a length equal to A-B minus 200 millimeters or distance (B) to (D).
3. Drill a hole in the top of the tank large enough to suit a cable grommet or strain relief grommet (F) - not supplied.
4. Snap off retainer clip (C) from top of weight (D).
5. Position retainer clip 100mm from float ball (E).
6. Slide weight (E) over retaining clip and firmly snap into position.
7. Lower weight into tank and feed top of cable through hole drilled in Step 3.
8. Fasten with cable grommet to previously measured length (A) to (B).

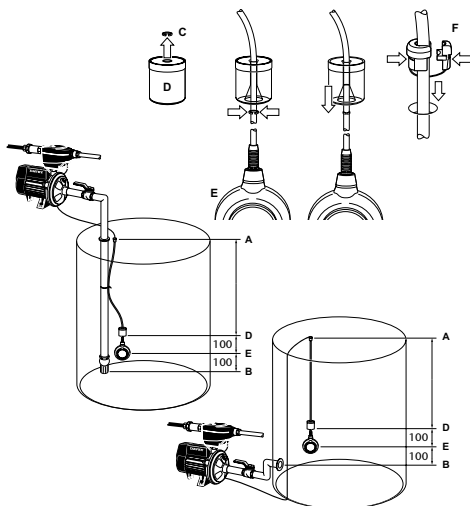

STEP 3b - ALTERNATE SIDE ENTRY FLOAT SWITCH 32398

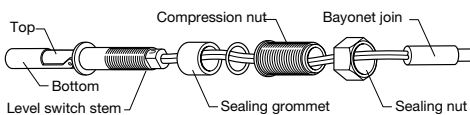

⚠ IMPORTANT

- The level switch is suitable for installation in polyethylene and fibreglass tanks. It can be fitted in steel tanks but cutting through the zinc alum or colourbond coating of the tank exposes bare steel and this can rust. Check with the tank manufacturer before drilling.
- The float switch is designed to be installed from the outside of the tank. There is no need to get inside the tank.
- The sealing grommet of the float switch is designed to work in a

maximum tank wall thickness of 25mm. It is not suitable for concrete or very thick plastic walled tanks. There is an alternative float switch that can be lowered into the top of these types of tanks (Davey p/n: 13961).

Work out the correct position for the hole for the float switch. With a corrugated profile tank wall this is on the upper flat section of the profile as shown below.

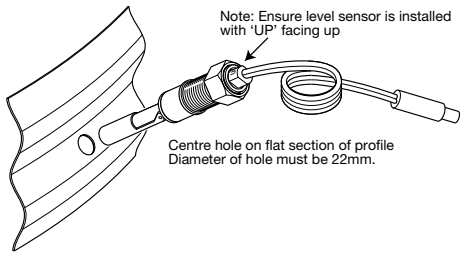

Work out the correct location of the float switch relative to the pump outlet.

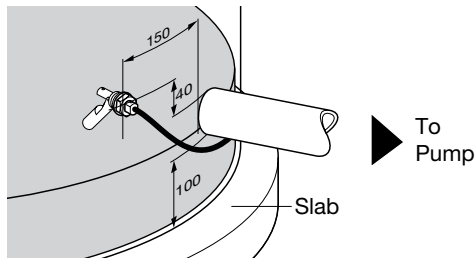

The float switch location should also be:

- At least 40mm above the pump inlet.
- Placed away from the rainwater entry into the tank so that the incoming flow does not interfere with the operation of the switch.

Before cutting the hole check again that the 5m lead from the float switch will reach the RainBank and plug comfortably into it.

1. Drill a 22mm hole in the side of the tank in the correct position. A spade drill is the best tool for this job. Ensure all swarf is removed from the hole. If installing the switch in a corrugated tank you should make sure that it is installed on the flat section between the radii as shown below.

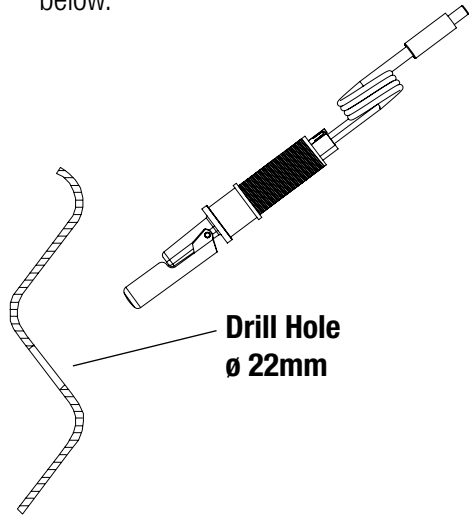

2. Ensure the compression nut is loosened so that the sealing grommet is not expanded. Remove the sealing nut and insert the switch into the hole as below.

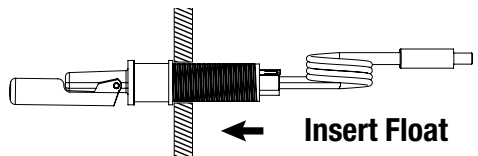

3. The switch will not work properly if it is not properly orientated. Make sure the word "UP" is seen at the very end of the switch body. Now tighten the compression nut to expand the seal (as shown below).

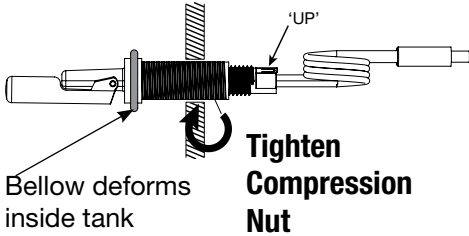

4. Ensure that the switch is still correctly orientated. With the word "UP" visible, screw on and tighten the sealing nut to finish the installation of the float switch.

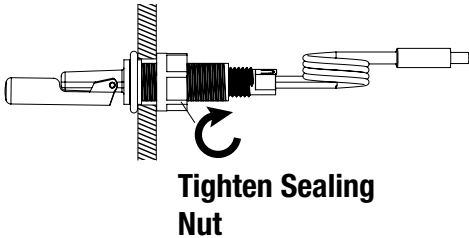

STEP 4 - CHECK PIPE WORK

Make sure the final assembled position of your RainBank will align well with the mains and rainwater pipe.

The pump and RainBank should be assembled so that the mains water supply to the unit and rainwater outlet to toilets and laundry connect easily to the plumbing on the same level.

STEP 5 - CONNECT PUMP TO RAINBANK

Connect your pump to the RainBank

1. Screw rotary coupling into outlet of pump (teflon tape not required).

STEP 6 - CONNECT PIPES

Connect the RainBank to the mains water and delivery pipe plumbing.

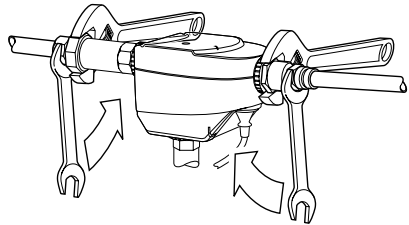

⚠ IMPORTANT

- To allow easy connection it is strongly recommended that you have flexible copper pipes that allow some movement so that they can line up exactly with the mains water and rainwater outlet. These pipes must be $\frac{3}{4}$ inch in diameter.

- It is highly recommended that an isolation valve be fitted to where the mains water enters RainBank and between the pump and the rainwater tank. This facilitates easy removal of the unit if required without turning off the household water or losing stored rainwater.
- Do not use thread sealing compounds, hemp or pipe glue. Do not use crimped fittings.
- All RainBank plumbing fittings feature rotating unions that require bracing.
- If your access to the bottom of the RainBank unit is difficult you may have to connect the 5 volt connection from the float switch before the plumbing is connected.

STEP 7

1. Connect the pump power lead to the three-pin socket underneath RainBank.



IMPORTANT

This must connect to the RainBank controller not the power point. If the pump is connected to the power point the pump will run constantly, shortening the life of the pump and potentially running the pump dry.

2. Connect the three-pin power plug from the RainBank to your power point.
3. Connect the 5 volt lead from the float switch to its flying lead; in the underside of the unit. This is not necessary if you are using a submersible pump as the float switch is already part of the pump.

Connect all leads.

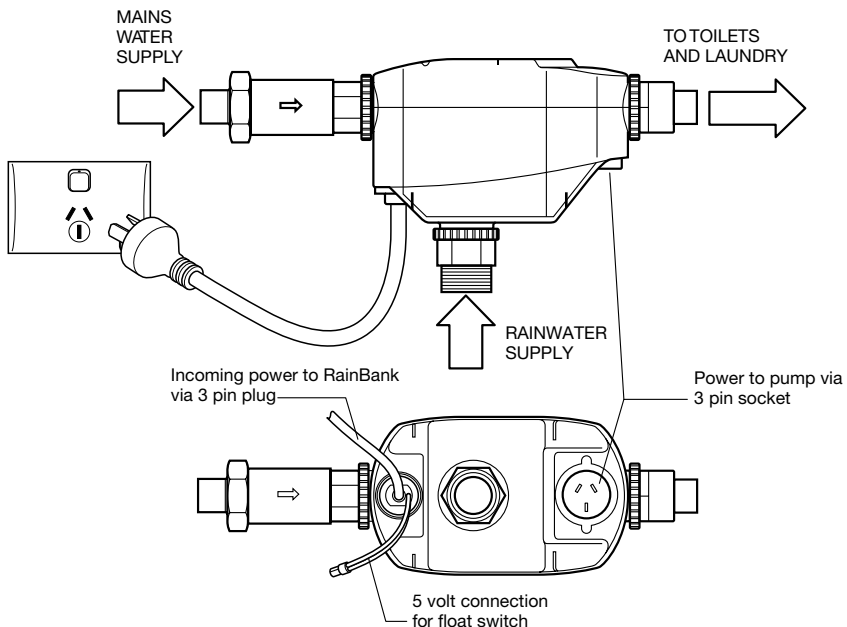

To protect against electrical surges and lightning strike damaging RainBank or its pump we strongly recommend the use of a suitable surge protection device and residual current devices.

STEP 8 - TESTING

Test the operation of RainBank.

1. With the mains connected and the rainwater tank empty turn on one of the taps in the laundry that feed the washing machine or flush the toilet. Mains water should flow normally. The pump should **not** turn on. The **'status'** light should glow **'red'** to indicate that mains water is being used. When this is completed turn off tap.
2. Fill the rainwater tank with sufficient water to activate or cover the float switch.
3. Check that the pump is correctly primed and there are no air locks that will interfere with its operation as per the Davey instructions. This is essential for the proper operation of the unit. See the instructions on how to do this for all types of Davey pump in the Priming section on page 26.
4. Turn on a tap or flush a toilet in the rainwater system. The pump should run and deliver rainwater. Allow to run for several minutes to clear air from pipes. The **'status'** light will now glow **'green'**.

5. Remove the float switch connection from the RainBank – this should stop the pump and confirms that the float switch and power connections have been made correctly – refit the float switch connection. The **'status'** light will now glow **'red'**. Press the manual override button to operate the pump if needed. The **'status'** light will glow **'yellow'** while the manual override button is depressed.

NOTE: Mains water indicator light is not applicable in RainBank 'S' models.

6. Check for leaks around RainBank, the pump, pipework and fittings.

INSTALLATION TYPE 2 Above ground tank with submersible pump inside eg: KRBS1 & 2

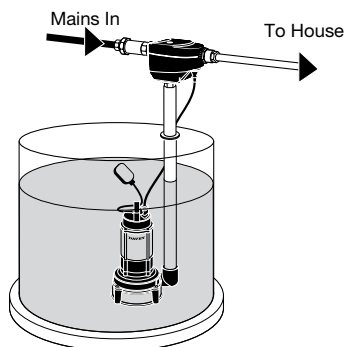

IMPORTANT

- This type of pump comes with its own float switch system to detect water level so it is not necessary to drill the tank to fit a float switch.

- Failure to prime the submersible pump prior to connection of the pump to RainBank can cause an air lock that may prevent the pump operating properly.

The following sections of the Type 1 installation instructions are applicable to Type 2 installations.

Step 2 – Work out the position of your RainBank with regard to distance to power. The float switch lead is not an issue here.

Step 4 – Align the RainBank for easy fitting to the plumbing and fit Davey wall bracket if required.

Step 5 – Connect RainBank to your submersible pump as per instructions on page 25.

Step 6 – Connect the RainBank to the plumbing as for Installation Type 1 on page 19.

Step 7 – Connect all leads as per Installation Type 1 on page 20. There is no float switch lead as this is fitted to the submersible pump.

Step 8 – Test the unit - page 21.

INSTALLATION TYPE 3

Below ground tank with submersible pump D42A/B & D53A/B

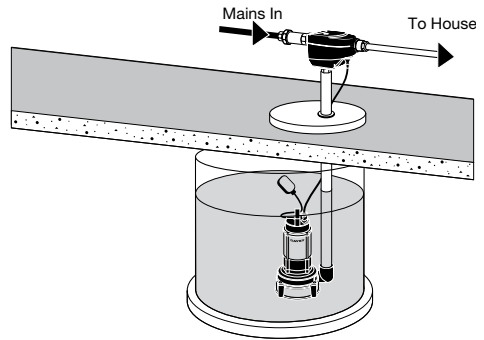

! IMPORTANT

- Under AS/NZS 3500.1 collecting/storing rainwater in a partially buried tank is considered a medium level hazard. Even though RainBank has a built-in dual check back flow valve, you may be required to fit additional backflow protection valves to satisfy this requirement – check with your local council as to their guidelines on rainwater tank installation and backflow prevention.

There is no need for a separate float switch as this comes attached to the submersible pump and does not plug into the RainBank unit.

You should carry out the following steps as per the instructions for Installation Type 1

Step 2 – Work out the position of your RainBank with regard to distance to power. The float switch lead is not an issue here.

Step 4 – Align the RainBank for easy fitting to the plumbing. Fit Davey wall bracket.

Step 5 – Connect RainBank to your submersible pump as per instructions on page 25.

Step 6 – Connect the RainBank to the plumbing.

Step 7 – Connect all leads (no float switch lead to plug in)

Step 8 – Test the unit - page 21

**INSTALLATION TYPE 4
Below ground tank with pump
above tank and suction lift**

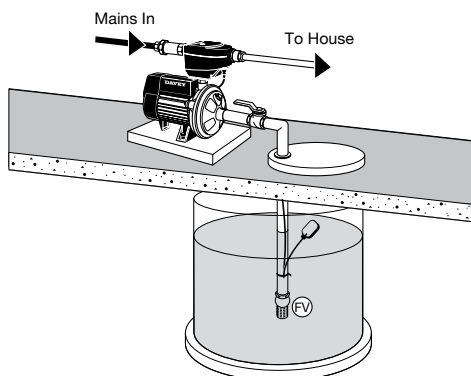

! IMPORTANT

- Under AS/NZS 3500.1 collecting/storing rainwater in a partially buried tank is considered a medium level hazard. Even though RainBank has a built-in dual check back flow valve you may be required to fit additional backflow protection valves to satisfy this requirement.

NOTE: To allow for the correct operation of your RainBank and for movement of the tank and pump which may occur over time, the suction pipe must have a length of flexible suction hose from pump to top of tank. This hose can be braided hose, reinforced suction hose or polythene pipe at least 1 metre in length.

The following sections of the Type 1 installation instructions are applicable to Type 4 installations.

Step 1 – Evaluate and select the best pump site as close to the water source and water level as possible.

Step 2 – Work out the position of your RainBank with regard to distance to power.

Step 3 – Plumb up your suction plumbing ensuring that the lowest point in the inlet pipe is at least 200mm below the lowest water level and at least 100mm above the base of the tank.

Step 4 – Install the float switch. Check that the float switch lead (9m long) will reach the RainBank. For greater distances between your rainwater tank and pump, a 10m float switch (top and side entry) extension lead (Davey Part No. 14186) will need to be added. Up to 4 float switch extension leads can be added between the pump and the rainwater float switch lead. It is recommended that the float switch extension lead/s are in a protective conduit.

The float end should be set up so it can fall no lower than 100mm above the level of the lowest point in the inlet pipe so the pump will always be shut off well before it can run dry or draw in air.

This is secured to the pump suction pipe with cable ties. Allow no more than 100mm of cable between the float and the lowest cable tie.

The plug end should be plugged into the float switch inlet on the underside of the RainBank unit in Step 8.

Step 5 – Align the RainBank for easy fitting to the plumbing.

Step 6 – Connect RainBank to the pump.

Step 7 – Connect RainBank to the plumbing.

Step 8 – Connect all leads.

Step 9 – Test the unit - page 21.

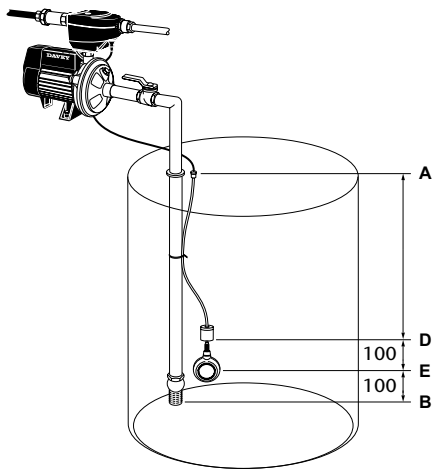

INSTALLATION OF SUBMERSIBLE PUMPS

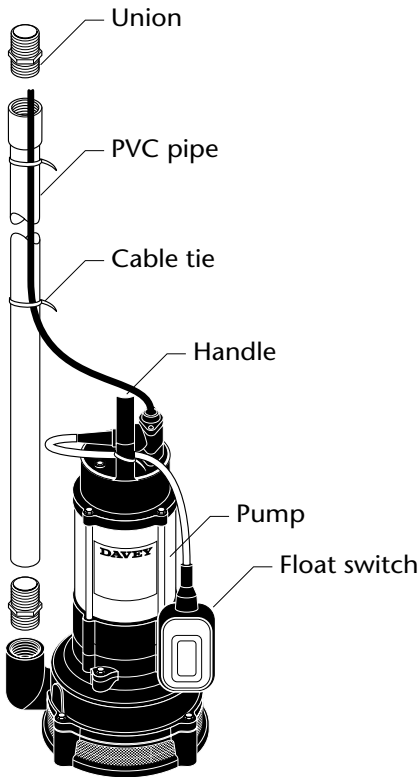

1. Use Teflon tape on the pipe to pump connection.
2. Secure the power cable to the delivery pipe with cable ties.



IMPORTANT

Do not pull on power lead. Fit a rope to handle for lowering and raising pump.

3. Place pump into tank.
4. Davey recommends the fitting of floating inlets to submersible pumps to minimise any possibility of sludge intake. Part number to suit pump D42A/B is FI-42.

PRIMING PUMPS

Type 1 installations. Above ground tank and pump outside tank.

1. Remove the priming plug on the top of the pump and fill the casing and suction line with water then refit plug. If there is an isolation valve fitted on the delivery pipe from the rainwater tank (as recommended) this needs to be opened.

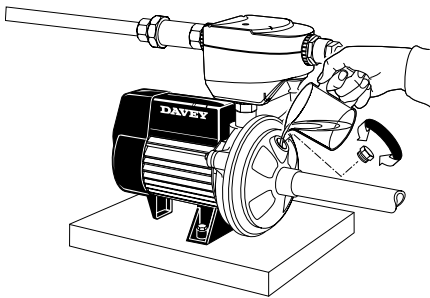

If there is an air lock i.e. the pipe and pump casing is not fully filled with water, the pump may not draw water. If this is the case you should repeat the priming procedure. If the pump still does not draw properly this may be a fault in the way the delivery pipe is installed. The pump should be slightly higher than the pipe inlet and this should run up hill to the pump at a slight but consistent slope so that any air is expelled at the pump end as the pump is primed.

2. Hold down 'manual override' button on the RainBank to operate pump to clear trapped air. Make sure an outlet (tap) is open so that air and water can be dispelled and ensure the mains water is turned off until the pump is fully primed.

! IMPORTANT

Leaky joins can also cause a loss of prime. NOTE: The pump must be below the float switch.

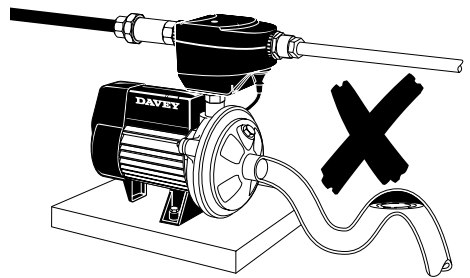

Type 2 and 3 installations. Submersible pumps inside tank.

Provided the pump is sitting in sufficient water the pump will self prime and push air out of the taps and appliances that are used at the other end. To let this air out without causing damage, it is important that:

- All taps connected to the rainwater system are turned on.
- Toilets connected to the system are flushed so the cistern fills and any air is cleared from the line.

Type 4 installations. External suction pump drawing from below ground tank.

Pump inlet should be at least (200mm) below the lowest water level for reliable operation.

Priming is as for Type 1 installations. If there is a significant amount of water required to do this it can be a good idea to fit the highest area of the pipe with an access plug in a T piece so that the pipe can be filled more quickly with a bucket when repriming.

MAINTAINING RAINBANK

RainBank does not need maintenance but there are things you can do to ensure its most reliable operation.

- Fit a “first flush” system that ensures the first run of dirty rainwater does not go into the tank.
- Clean your gutters and first flush devices and ‘Y’ strainers regularly.
- Remove branches that over hang your roof.
- Have a strainer fitted to your rainwater tank inlet and regularly check this for leaves and twigs, etc.
- You should also check for debris in the bottom of your tank a few times a year and clean this out if necessary. A first flush system will greatly reduce the need for this action.
- This automatic thermal overload switch can start the pump without warning. Always disconnect the controller and/or pump motor from the electrical supply before maintenance or repairs.
- Care should also be taken when servicing or disassembling pump to avoid injury from hot pressurised water. Unplug the pump, relieve the pressure by opening a tap on the discharge side of the pump and allow any hot water to cool before attempting to dismantle.
- Do not use petroleum based fluids or solvents (e.g. oils, kerosene, turpentine, thinners, etc. on the plastic or seal components).
- Do not use hydrocarbon based or propelled sprays around the electrical components of the controller.
- During servicing use only approved non petrochemical based oring and gasket lubrication. If unsure consult your Davey Dealer for advice.



IMPORTANT MAINTENANCE PRECAUTIONS

- Davey pump motors are fitted with an automatic thermal overload switch that stops the motor if the motor gets too hot to avoid damaging it. This automatically re-starts the motor when the temperature within the pump has dropped to a safe level. Constant tripping of this switch indicates a problem e.g. Low voltage at pump, etc.

SYMPTOM: PUMP WILL NOT SWITCH OFF

- 1. Pump plugged directly into power outlet.** Plug lead from pump into base of RainBank as per installation instructions on pg 20.
- 2. Water is still being used.** Check all taps, toilets and appliances connected to RainBank system to ensure they are turned off.
- 3. Water is leaking on discharge side of RainBank system.** Check for leaks and repair.
- 4. Rock or debris caught inside RainBank.** Call your plumber to fit a 'Y' strainer – RainBank will need to be returned to Davey.

SYMPTOM: PUMP WILL NOT SWITCH ON

1. Pump not plugged in.

Plug pump into base of RainBank and RainBank into power supply. See page 20.

2. No power supply to pump.

Contact electrician and have power restored.

3. Float switch not connected to RainBank.

Plug float lead into base of RainBank. The connection lead is located next to the power lead coming from the RainBank.

To confirm the connection is correct, depress 'manual override' button, pump will start.

4. No water in tank.

Check water level in tank.

5. Float switch located at water tank is installed incorrectly.

Check position of float. See pages 16-19.

6. Mains water supply not connected to RainBank.

RainBank system must have a pressurised water supply connected to inlet. Press 'manual override' button to simulate mains water flowing.

7. Mains supply to RainBank turned off.

Turn on mains water supply. Press 'manual override' button to simulate mains water flowing. Pump will start if rain water is available.

8. Pump is faulty.

To confirm if the fault is within the pump, plug the pump directly into power point and check to see if it starts. If the pump starts plug the pump back into the RainBank and continue fault finding. If the pump does not start contact your supplier for further advice.

9. Lead from float switch to pump broken or damaged.

Replace float and lead assembly.

10. Float switch defective.

Contact your supplier for further advice.

11. Mains water flow is too low.

Ensure flow at most distant outlet is above 5 litres per minute.

OTHER SYMPTOMS:

Mains water is still in use when pump is running. Possible cause – pump needs to be primed. Stop pump and remove priming plug from front top of pump (right above water inlet) and allow all air to escape from pump. Replace the priming plug when water dribbles out of hole (see page 26).

Mains water is still in use when pump is running. Possible cause – debris is caught inside RainBank preventing plunger mechanism from sealing completely. Contact your plumber to fit a 'Y' strainer to system between tank & RainBank.

Mains water is still in use when pump is running. Possible cause – pump impeller blocked. Have pump serviced. Fit first flush devices and 'Y' strainer to pipework.

Mains water not passing through RainBank. Possible cause – RainBank installed backwards. Install RainBank according to installation & operating instructions. Arrow on top of RainBank indicates direction of flow.

Mains water not passing through RainBank. Possible cause – debris is blocking inlet to RainBank. Remove RainBank and clean inlet. Check all filters are clean.

Mains water pressure and flow too low. Possible cause – there is a check valve or PRV installed between RainBank and tank. Remove check valve or PRV from plumbing. Check all filters in plumbing are clean.

Pump hums. Possible cause – pump is jammed or seized. Have pump serviced.

Water leaking from connection between pump and RainBank. Possible cause - installer has failed to fit connection kit correctly. Remove RainBank and re-install connection kit.

Mains water filling up tank. Possible cause – debris caught inside RainBank. Install first flush devices and 'Y' strainer.

Green light flashing.
Boot-up sequence only.

Red light flashing. Pump has lost prime and needs to be filled with water, see page 26. Pump will automatically retry at: 1, 5, 30, 60 and 120 minute intervals.

Pump takes 10 seconds to start.
This is anti-cycling software that allows 1 start every 10 seconds.

WARNINGS

- Before installing your RainBank controller, please read all instructions carefully as failures caused by incorrect installation or operation are not covered by the guarantee. Your RainBank controller is designed to handle clean water. The system should not be used for any other purpose without specific referral to Davey. The use of the system to pump flammable, corrosive and other materials of a hazardous nature is specifically excluded.
- **WARNING:** Water freezing inside the RainBank will damage the unit. Locate your RainBank and pump so that they are not susceptible to freezing.
- RainBank must be installed and serviced by a licensed plumber.
- Check with your local water authority on water restrictions when your rainwater tank is connected to mains water.
- Do not enter a empty rainwater tank – they may contain hazardous gases.
- Secure all openings to the rainwater tank to ensure it will not permit access to children.



Installation Inside Buildings: To cater for possible plumbing leaks or damage to the RainBank system components, the installation must include an enclosure that will capture any water spraying from the plumbing or RainBank system and direct it into a properly constructed drain tray.



Note: When installing a RainBank and/or associated pump system inside a building, allowance for possible high pressure leakage **MUST** be made.



Note: In order to carry out routine maintenance to the RainBank **MUST** be easily accessible to the end user or home owner.



Note: If the supply cord is damaged, it must be replaced by manufacturer, its service agent or similarly qualified persons in order to avoid a hazard.

PLUMBERS TIPS

1. Install pump on a level, solid, well drained site (this will reduce noise and pipe stress).
2. Fit first flush devices to all down pipes to ensure clean water inside the tank (dirty tank water can stain toilets & clothes).
3. Clear swarf from all pipes and holes drilled into the tank (swarf can block valves, RainBank and toilet valves). Fit a 200 micron 'Y' strainer before the pump or between the pump and RainBank.
4. Fit a stop valve on mains water line before RainBank (makes servicing easier).
5. Fit a stop valve between pump and tank outlet (makes servicing easier).
6. Check with local council plumbing teams for backflow requirements.
7. Keep pipe work well braced as vibrations can become noisy.
8. Fill rainwater tank above float switch with garden hose to check system.
9. Make sure pump is full of water (primed) before leaving site. Flush all air out of system by running pump with an outlet downstream open.

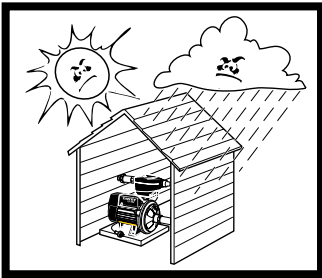

Protect from the weather

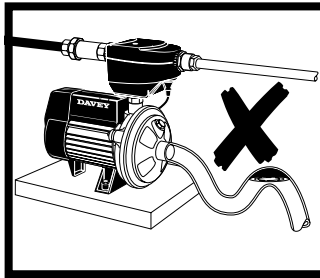

Don't create air locks!

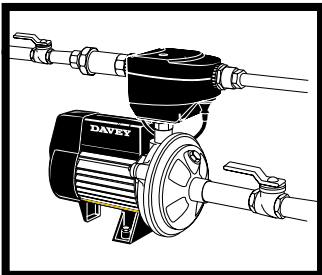

Fit isolation valves

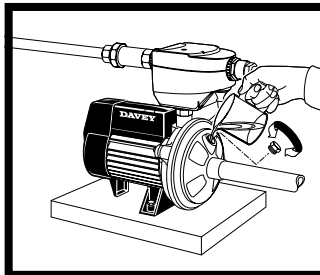

Prime pump before switching on

Davey Repair or Replacement Guarantee

In the unlikely event in Australia or New Zealand that this Davey product develops any malfunction within warranty periods beginning from the date of original purchase due to faulty materials or manufacture, Davey will at our option repair or replace it for you free of charge, subject to the conditions below.

Davey Guarantee Period

RainBank Controller - Three Years

Pump - Two Years

Should you experience any difficulties with your Davey product, we suggest in the first instance that you contact the Davey Dealer from which you purchased the Davey product. Alternatively you can phone our Customer Service line on 1300 367 866 in Australia, or 0800 654 333 in New Zealand, or send a written letter to Davey at the address listed below. On receipt of your claim, Davey will seek to resolve your difficulties or, if the product is faulty or defective, advise you on how to have your Davey product repaired, obtain a replacement or a refund.

Your Davey Guarantee naturally does not cover normal wear or tear, replacement of product consumables (i.e. mechanical seals, bearings or capacitors), loss or damage resulting from misuse or negligent handling, improper use for which the product was not designed or advertised, failure to properly follow the provided installation and operating instructions, failure to carry out maintenance, corrosive or abrasive water or other liquid, lightning or high voltage spikes, or unauthorised persons attempting repairs. Where applicable, your Davey product must only be connected to the voltage shown on the nameplate.

Your Davey Guarantee does not cover freight or any other costs incurred in making a claim. Please retain your receipt as proof of purchase; you **MUST** provide evidence of the date of original purchase when claiming under the Davey Guarantee.

Davey shall not be liable for any loss of profits or any consequential, indirect or special loss, damage or injury of any kind whatsoever arising directly or indirectly from Davey products. This limitation does not apply to any liability of Davey for failure to comply with a consumer guarantee applicable to your Davey product under the Australian or New Zealand legislation and does not affect any rights or remedies that may be available to you under the Australian or New Zealand Consumer Legislation.

In Australia, you are entitled to a replacement or refund for a major failure and for compensation for any other reasonably foreseeable loss or damage. You are also entitled to have the goods repaired or replaced if the goods fail to be of acceptable quality and the failure does not amount to a major failure.

Should your Davey product require repair or service after the guarantee period; contact your nearest Davey Dealer or phone the Davey Customer Service Centre on the number listed below.

For a complete list of Davey Dealers visit our website (davey.com.au) or call:

DAVEY

Davey Water Products Pty Ltd
Member of the GUD Group
ABN 18 066 327 517

daveywater.com

AUSTRALIA

Customer Service Centre

6 Lakeview Drive,
Scoresby, Australia 3179
Ph: 1300 232 839
Fax: 1300 369 119
Email: sales@davey.com.au

NEW ZEALAND

Customer Service Centre

7 Rockridge Avenue,
Penrose, Auckland 1061
Ph: 0800 654 333
Fax: 0800 654 334
Email: sales@dwp.co.nz

® Davey is a registered trademark of Davey Water Products Pty Ltd. © Davey Water Products Pty Ltd 2021.

* Installation and operating instructions are included with the product when purchased new. They may also be found on our website.

DAVEY

Davey Water Products Pty Ltd
Member of the GUD Group
ABN 18 066 327 517

daveywater.com

AUSTRALIA

Customer Service Centre

6 Lakeview Drive,
Scoresby, Australia 3179
Ph: 1300 232 839
Fax: 1300 369 119
Email: sales@davey.com.au

NEW ZEALAND

Customer Service Centre

7 Rockridge Avenue,
Penrose, Auckland 1061
Ph: 0800 654 333
Fax: 0800 654 334
Email: sales@dwp.co.nz

© Davey is a registered trademark of Davey Water Products Pty Ltd. © Davey Water Products Pty Ltd 2021.

P/N 401336-13

DAVEY

HM Series Electric Pumps

Installation and Operating Instructions



WARNING: The pump and associated pipework operate under pressure. Under no circumstances should the pump or associated pipework be disassembled unless the internal pressure of the unit has been relieved. Failure to observe this warning will expose persons to the possibility of personal injury and may also result in damage to the pump, pipework or other property.



WARNING: Failure to follow these instructions and comply with all applicable codes may cause serious bodily injury and/or property damage.

Please pass these instructions on to the operator of this equipment.



IMPORTANT - outside Australia & New Zealand

Only a locally acceptable plug can be used for this product (Please use certified plugs only in compliance with your local regulations).

The installation can be only performed by a licensed/ registered electrical installer.

Please connect certified plug onto power cable in compliance with local regulations: Active (Brown) Neutral (Blue) and Earth (Green/yellow)

Prior to using this pump you must ensure that:

- The pump is installed in a safe and dry environment
- The pump enclosure has adequate drainage in the event of leakage
- Any transport plugs are removed
- The pipe-work is correctly sealed and supported
- The pump is primed correctly
- The power supply is correctly connected
- All steps have been taken for safe operation

Appropriate details for all of these items are contained in the following Installation and Operating Instructions. Read these in their entirety before switching on this pump. If you are uncertain as to any of these Installation and Operating Instructions please contact your Davey dealer or the appropriate Davey office as listed on the back of this document.

Congratulations on your purchase of a high quality, Davey multistage pump. All components have been designed and manufactured to give trouble free, reliable operation.

Before installing your new pump, please read all instructions carefully as failures caused by incorrect installation or operation are not covered by the guarantee. Your HM Electric Pump is designed to handle clean water. The pump should not be used for any other purpose without specific referral to Davey. The use of the pump to pump flammable, corrosive and other materials of a hazardous nature is specifically excluded.

General

Applications

Pumps for clear liquids, free of abrasives in residential, agricultural, industrial, and other applications.

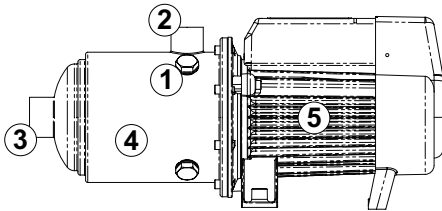

1. Priming Plug
2. Discharge Outlet
3. Suction Inlet
4. Pump Body
5. Motor

Specifications

Liquid temperate range:

-15 to +105°C

Suction head:

depends on NPSH of pump

Choosing a Site

Choose a site with a firm base as close to the water source as possible with correct power supply. Make sure your pump is always connected to an adequate, reliable source of clean water.

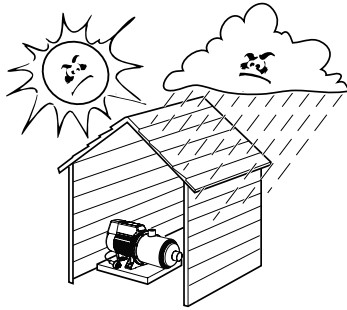
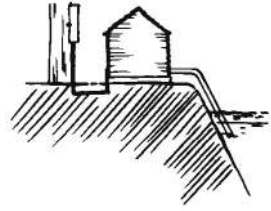

Housing your Davey Pump

To protect your pump from the weather, make sure the pump house is both water proof, frost free and has adequate ventilation.

The pump should be mounted on a firm base allowing for drainage, to avoid damage to flooring etc., that over time may occur from leaking pipe joints or pump seals. Do not mount the pump vertically. Never place flammable materials on or near your pump.

Power Connection



Connect lead to power supply designated on pump label, do not use long extension leads as they cause substantial voltage drop, poor pump performance and may cause motor overload.



The electrical connections and checks must be made by a qualified electrician and comply with applicable local standards. Poor installation or poor power supply may even result in electrical fires!



NOTE:

1. Ensure motor is connected to power supply specified on nameplate.
2. Avoid long extension leads as they can cause substantial voltage drop and operating problems.
3. Although the Davey electric motor is specifically engineered to perform on a range of power supply voltages, malfunctions or failure caused by adverse voltage supply conditions are not covered under guarantee.



In accordance with AS/NZ 60335.2.41 we are obliged to inform you that this pump is not to be used by children or infirm persons and must not be used as a toy by children.



WARNING: Automatic reset thermal overloads will allow the pump to restart without warning. **ALWAYS** disconnect the pump motor from the electrical supply before maintenance or repairs.

- Note:
1. Long extension leads should be avoided as they often have insufficient current carrying capacity to run electric motors, hence they can cause substantial voltage drop and operating problems.
 2. If the electrical fittings in your country make it necessary to remove the plug from the lead fixed to the motor care should be taken to ensure that the earth conductor green/yellow in the lead is properly connected to a good earth. This work must only be undertaken by an authorised electrician.

Three Phase

Some HM models are also available as 3 phase model for 50Hz, nominal 380-415V power supply. A recommended wiring diagram can be found inside the capacitor cover (see figure one below). Three phase units must be wired in by an authorised electrician in conjunction with a contactor which has “quicktrip” (M10) overloads set at nameplate current.

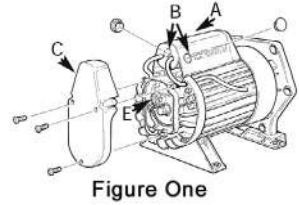

Davey recommend the use of overloads which also have the ability to detect “single phasing” or “dropped phase” conditions in the power supply.

Three phase models with output power of below 1.4kW have been designed to provide cable entry on the right hand side when viewed from the non-drive or fan end of the motor. A terminal block is provided under the capacitor cover. Note: Three phase motors do not have capacitors fitted in the capacitor cover.

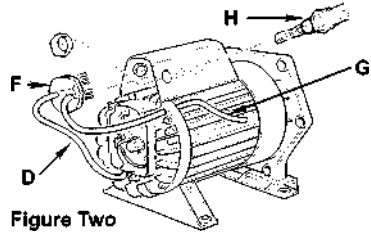

Depending on the motor, access to the terminal block is achieved by either removal of the fan cowl, or removal of the terminal cover. Before prising the fan cowl ensure the retaining screw has been removed.

IMPORTANT NOTE: THREE PHASE MODELS ONLY



Before finalising wiring connections, check that motor rotates in direction of arrow (clockwise when shaft is viewed from wiring connection end except HM270 models which rotate anti-clockwise). To alter rotation, change any two power leads at motor terminals.

When the unit is connected and operating the phase balance should be checked. This should be within 5% variation. “Rolling” the leads may help to improve a small unbalance, but major phase unbalance will usually be attributed to an input power unbalance. This must be addressed before the pump is used.



Power connections and wiring must be carried out by an Authorised Electrician. Means of disconnection must be incorporated in the fixed wiring, in accordance with local wiring rules.



WARNING: Some insects, such as small ants, find electrical devices attractive for various reasons. If your pump enclosure is susceptible to insect infestation you should implement a suitable pest control plan.

Pipe Connections



DO NOT USE THREAD SEALING COMPOUNDS, HEMP OR PIPE DOPE!

For best performance use PVC or polythene pipe at least the same diameter as the pump's inlet. Larger diameter pipe may be used to minimise resistance to flow when pumping longer distances.

Use unions at pipe connections to enable easy removal and servicing. Use sufficient tape to ensure airtight seal and hand

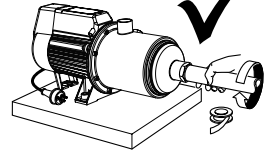
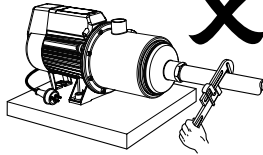

tighten only, do not screw connections all the way into suction port. To prevent strain on pump thread always support heavy inlet and outlet pipes. Lay suction pipe at a constant gradient to avoid air pockets which may reduce pump efficiency.



NOTE: Suction leaks are the largest cause of poor pump performance and are difficult to detect. Ensure all connections are completely sealed using thread tape only. DO NOT USE SEALING COMPOUNDS OR PIPE DOPE.

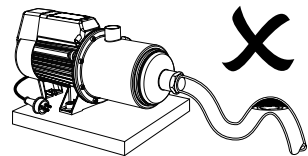

NEW Improved HM with self-priming and air handling capability

Your new HM pump or pressure system has the benefit of a new upgraded self-priming and air handling capability.

While Davey must stress the overall requirement for all suction lines to be air tight, we also are aware that sometimes removing air from suction lines or stopping minor leaks can be difficult. For this reason Davey have incorporated special features into your new pump or pressure system to make operation easier and more dependable.

To help you get the most from this new capability please read this addendum in conjunction with the full Installation and Operating Manual included with your pump.

Plumbing:

Pay special attention to ensuring the suction pipe and associated fittings are airtight. The absence of a water leak on the suction line may not confirm that the pipe or fittings are airtight.

In the event that the suction line contains air pockets it can aid the priming process greatly if you have the ability to temporarily isolate the discharge line from the pump and instead use an adjacent tap to allow the pump to discharge water until full prime is established. Such a facility is also useful for future servicing and troubleshooting should it be required.

Priming:

Filling the pump and suction line with water is made much easier by filling from the outlet side and allowing any trapped air in the pump to evacuate via one of the plugged holes on the pump casing.

- To do this with Torrium2 equipped models, temporarily remove the inbuilt check valve poppet from the Torrium2 and unscrew the SS plug from the casing besides the outlet.
- For pressure switch controlled models simply prime through the outlet tee with the plug removed. Remember that pressure switch controlled units require an inlet checkvalve or footvalve to be used.
- For manual pumps the provision of a priming tee on the outlet can make this task much easier. For temporary or permanent installation of manual pumps we strongly recommend the addition of an inlet checkvalve or footvalve as well.

Replace all plugs and the inbuilt check valve poppet in the Torrium2 prior to connecting power and switching on the pump.

Open the adjacent tap part way and isolate the downstream pipework until a good strong flow is established. This would indicate you have successfully “primed” the pump.

Close the adjacent tap and open the valve to the downstream pipelines.

Your pump is now ready for normal operation.

Connection to your Water Source

ABOVE GROUND WATER SOURCES

Installations with flooded suction require a gate valve so water supply can be turned off for pump removal and servicing.

Install a one-way check valve in the suction pipeline to avoid water draining back past the pump while not in operation and causing possible pump damage.

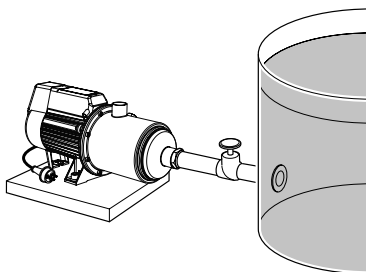

BELOW GROUND WATER SOURCES



NOTE: HM models require a foot valve or check valve to be installed in the suction pipework in suction lift applications as appropriate.

Whenever the installation position of the pump is higher than the lowest water level, a foot valve fitted to the end of the suction pipe as illustrated in (A) below is required. Ensure that the foot valve is at least $\frac{1}{2}$ metre below minimum water level.

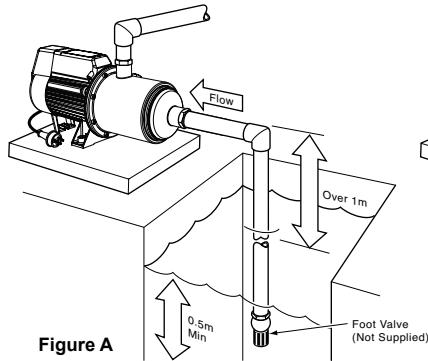

Figure A

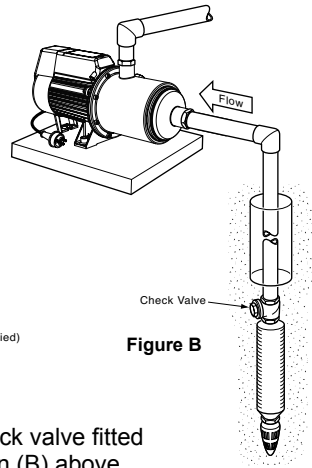



Figure B

SPEAR POINT INSTALLATIONS

When an HM is installed on a spear or well point a check valve fitted immediately on top of the spear point itself, as shown in (B) above.

 **NOTE: DO NOT** install the check valve at the pump or at the top of the well. **DO NOT** run the pump without water.

 **NOTE: Be certain to select the spear point to suit the well conditions and regulate the flow rate from the pump accordingly.**

Spear Size	Mesh	Approx. Max. Capacity of Spear Point	
1 ¹ / ₄ " (32mm)	60	15 - 23 l/min	or 200 - 300 gal/hr
1 ¹ / ₂ " (38mm)	60	23 - 38 l/min	or 300 - 500 gal/hr
2" (50mm)	60	38 - 75 l/min	or 500 - 1000 gal/hr

Dry-running protection

To avoid accidental loss of prime of the pump, we recommend protecting it with a suitable device. Note: damage from dry-running is not covered by guarantee.

Connection of Mains Scheme or Town Water Supply to either Suction or Discharge of Pumps

Most Water Supply Authorities have strict regulations regarding direct connection of pumps to mains water supplies. In most cases an isolating tank is required between mains supply and pump. Davey also recommend this method. Directly applied mains pressure can exceed pump operating pressure and damage pump.

Davey Water Products Pty Ltd can not accept responsibility for loss or damage resulting from incorrect or unauthorised installations.

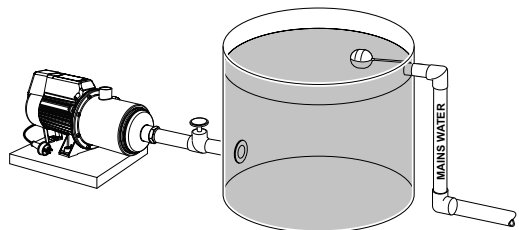

Priming and Operation

The pump body and suction line should be filled by pouring water into the priming plug hole adjacent to the outlet. Screw on the priming plug, close the discharge valve two thirds and switch pump on. Gradually open the discharge valve and the pipeline fills.

In high suction lift conditions, the pump may make a noise similar to it pumping sand or gravel; this will usually be cavitation occurring. Reduce flow until the cavitation noise stops. Once the discharge pipeline fills you can open the valve. If the cavitation noise returns, close the discharge valve slightly until it stops.

In the case of installations where there is a positive suction pressure (flooded suction) remove the pump's priming plug and slowly open the gate valve in the suction piping to allow water to enter the pump from the suction line until all air is expelled. Replace the priming plug and fully open the gate valve in the suction line and switch the pump on.

Prime should be established almost immediately, however, it may be necessary to re-prime several times on some installations before fully established optimum pump performance is obtained.



Do not run pump dry or allow to run continuously in a loss of prime condition. If this pump is allowed to pump water containing sand or other abrasive material, the effective life of the pump will be shortened.

If pump runs but will not pump water, check for the following:

1. Suction line and pump body not filled with water.
2. Leaking foot valve.
3. Air leaks in suction lines.
4. Air trapped in suction line (even on flooded suction) possibly when there is an uneven rise in the piping from water to pump (eliminate "humps and hollows")

1. Ensure outlet nearest to pump is open.



3. Switch on.

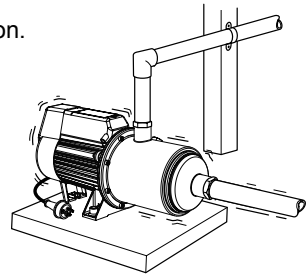

2. Fill pump body and suction line through priming plug hole located above suction inlet and replace plug.

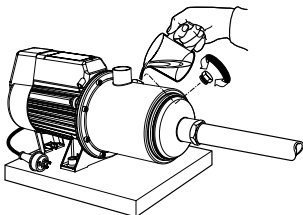

4. Prime should establish almost immediately with a strong flow of water, however, in some installations it may be necessary to repeat the above operation to remove all air from the system.





WARNING:
DO NOT RUN DRY.
DO NOT RUN WITH LOSS OF PRIME.
DO NOT PUMP WATER CONTAINING ABRASIVE MATERIALS.

Trouble Shooting Check List

MOTOR OPERATING BUT NOT PUMPING

1. Suction line and pump body not filled with water.
2. Leaking foot valve.
3. Air leaks in suction lines or suction pipe not under water.
4. Air trapped in suction lines (also possible with flooded suction) due to uneven rise in piping (eliminate humps and hollows).
5. No water at source or water level too low.
6. Valve on suction or delivery lines closed.

MOTOR NOT RUNNING

1. Power not connected.
2. Supply voltage too low.
3. Overload tripped.
4. Motor not free to turn e.g. a blocked impeller.
5. Internal motor fault.

MOTOR RUNS FOR SOME TIME THEN STOPS - RESTARTS AUTOMATICALLY AFTER SHORT TIME

- Overload tripping in motor
- low voltage at motor terminals
 - motor in direct sunshine or in "hot box"
 - motor not free to turn (eg: blocked)



***NOTE "MOTOR PROTECTION DEVICE" :**

For protection, the Davey pump motor is fitted with an automatic reset thermal overload, constant tripping of this overload indicates a problem e.g. low voltage at pump, excessive temperature in pump enclosure.



WARNING: When servicing or attending pump, always ensure power is switched off and lead unplugged. Electrical connections should be serviced only by qualified persons.



Care should also be taken when servicing or disassembling pump to avoid possible injury from hot pressurised water. Unplug pump, relieve pressure by opening a tap on the discharge side of the pump and allow any hot water in the pump to cool before attempting to dismantle.



IMPORTANT:

DO NOT USE petroleum based fluids or solvents (e.g. Oils, Kerosene, Turpentine, Thinners, etc) on the plastic pump components or seal components.



WARNING: Do not use hydrocarbon based or hydrocarbon propelled sprays around the electrical components of this pump.

Davey Warranty

Davey Water Products Pty Ltd (Davey) warrants all products sold will be (under normal use and service) free of defects in material and workmanship for a minimum period of one (1) year from the date of original purchase by the customer as marked on the invoice, for specific warranty periods for all Davey products visit daveywater.com.

This warranty does not cover normal wear and tear or apply to a product that has:

- been subject to misuse, neglect, negligence, damage or accident
- been used, operated or maintained other than in accordance with Davey's instructions
- not been installed in accordance with the Installation Instructions or by suitably qualified personnel
- been modified or altered from original specifications or in any way not approved by Davey
- had repairs attempted or made by other than Davey or its authorised dealers
- been subject to abnormal conditions such as incorrect voltage supply, lightning or high voltage spikes, or damages from electrolytic action, cavitation, sand, corrosive, saline or abrasive liquids,

The Davey warranty does not cover replacement of any product consumables or defects in products and components that have been supplied to Davey by third parties (however Davey will provide reasonable assistance to obtain the benefit of any third-party warranty).

To make a warranty claim:

- If the product is suspected of being defective, stop using it and contact the original place of purchase. Alternatively, phone Davey Customer Service or send a letter to Davey as per the contact details below
- Provide evidence or proof of date of original purchase
- If requested, return the product and/or provide further information with respect to the claim. Returning the product to the place of purchase is at your cost and is your responsibility.
- The warranty claim will be assessed by Davey on the basis of their product knowledge and reasonable judgement and will be accepted if:
 - o a relevant defect is found
 - o the warranty claim is made during the relevant warranty period; and
 - o none of the excluded conditions listed above apply
- The customer will be notified of the warranty decision in writing and if found to be invalid the customer must organise collection of the product at their expense or authorise its disposal.

If the claim is found to be valid Davey will, at its option, repair or replace the product free of charge.

The Davey warranty is in addition to rights provided by local consumer law. You are entitled to a replacement or refund for a major failure and compensation for any other reasonably foreseeable loss or damage. You are also entitled to have the goods repaired or replaced if the goods fail to be of acceptable quality and the failure does not amount to a major failure.

For any internet connected products the consumer is responsible for ensuring a stable internet connection. In the event of a network failure the consumer will need to address the concern with the service provider. Use of an App is not a substitute for the User's own vigilance in ensuring the product is working to expectation. Use of a Smart Product App is at the User's own risk. To the fullest extent permitted by law Davey disclaims any warranties regarding the accuracy, completeness or reliability of App data. Davey is not responsible for any direct or indirect loss, damage or costs to the User arising from its reliance on internet connectivity. The User indemnifies Davey against any claims or legal actions from them or others relying on internet connectivity or App data may bring in this regard.

Products presented for repair may be replaced by refurbished products of the same type rather than being repaired. Refurbished parts may be used to repair the products. The repair of your products may result in the loss of any user-generated data. Please ensure that you have made a copy of any data saved on your products.

To the fullest extent permitted by law or statute, Davey shall not be liable for any loss of profits or any consequential, indirect or special loss, damage or injury of any kind whatsoever arising directly or indirectly from Davey products. This limitation does not apply to any liability of Davey for failure to comply with a consumer guarantee applicable to your Davey product under local laws and does not affect any rights or remedies that may be available to you under local laws.

For a complete list of Davey Dealers visit our website (daveywater.com) or call:

DAVEY

Davey Water Products Pty Ltd
Member of the GUD Group
ABN 18 066 327 517

daveywater.com

AUSTRALIA

Head Office

6 Lakeview Drive,
Scoresby, Australia 3179
Ph: 1300 232 839
Fax: 1300 369 119
Email: sales@davey.com.au

NEW ZEALAND

7 Rockridge Avenue,
Penrose, Auckland 1061
Ph: 0800 654 333
Fax: 0800 654 334
Email: sales@dpw.co.nz

EUROPE

7 rue Eugène Hénaff 69200
Vénissieux, France
Ph: +33 (0) 4 72 13 95 07
Fax: +33 (0) 4 72 33 64 57
Email: info@daveyurope.eu

NORTH AMERICA

Ph: 1-888-755-8654
Email: info@daveyusa.com

MIDDLE EAST

Ph: +971 50 6368764
Fax: +971 6 5730472
Email: info@daveyuae.com